



# Contents A-Z

## OWNER'S MANUAL.

MINI COUNTRYMAN.

MINI PACEMAN.





**COOPER  
COOPER S  
JOHN COOPER  
WORKS**

## **Owner's Manual for Vehicle**

Thank you for choosing a MINI.

The more familiar you are with your vehicle, the better control you will have on the road. We therefore strongly suggest:

Read this Owner's Manual before starting off in your new MINI. It contains important information on vehicle operation that will help you make full use of the technical features available in your MINI. The manual also contains information designed to enhance operating reliability and road safety, and to contribute to maintaining the value of your MINI.

Supplementary information can be found in the additional brochures in the onboard literature.

Set off now and have fun with your MINI.

The MINI Team of BMW AG

© 2015 Bayerische Motoren Werke  
Aktiengesellschaft  
Munich, Germany  
Reprinting, including excerpts, only with the written  
consent of BMW AG, Munich.  
US English II/15, 03 15 500  
Printed on environmentally friendly paper, bleached  
without chlorine, suitable for recycling.

## ADDENDUM TO OWNER'S MANUAL

We wanted to provide you with some updates and clarifications with respect to the printed MINI Owner's Manual. These updates and clarifications will supersede the materials contained in that document.

1. Where the terms “service center,” “the service center,” “your service center,” “service specialist,” or “service” are used in the Owner's Manual, we wanted to clarify that the terms refer to a MINI dealer's service center or another service center or repair shop that employs trained personnel that can perform maintenance and repair work on your vehicle in accordance with MINI specifications.
2. Where the text of the Owner's Manual contains an affirmative instruction to contact a “service center” or “your service center,” we wanted to clarify that MINI recommends that, if you are faced with one of the situations addressed by that text, you contact or seek the assistance of a MINI dealer's service center or another service center or repair shop that employs trained personnel that can perform maintenance and repair work on your vehicle in accordance with MINI specifications.

While MINI, at no cost to you, will pay for repairs required by the limited warranties provided with respect to your vehicle and for maintenance under the Maintenance Program during the applicable warranty and maintenance coverage periods, you are free to elect, both during those periods and thereafter, to have maintenance and repair work provided by other service centers or repair shops.

3. Where the Owner's Manual makes reference to parts and accessories having been approved by MINI, those references are intended to reflect that those parts and accessories are recommended by MINI. You may elect to use other parts and accessories, but, if you do, we recommend that you make sure

that any such parts and/or accessories are appropriate for use on your vehicle.

4. At page 6 and page 7, under the warranty section's discussion of homologation, where it states that you “cannot lodge warranty claims for your vehicle there,” the text should read that you “may not be able to lodge warranty claims for your vehicle there.”
5. At page 7, in the “Parts and accessories” section, the sentence beginning “For your own safety ... ,” should be disregarded and the following text should be read in lieu thereof: “The manufacturer of your vehicle recommends using genuine MINI parts and accessories.” In the fifth sentence of that paragraph, the word “cannot” should read “does not.”
6. At page 39, in the “Checking and replacing safety belts” section, the text beginning, “Have the work performed only by your service center ...” should be disregarded and the following text should be read in lieu thereof: “MINI recommends having this work performed by a service center as it is important that this safety feature functions properly.”
7. At page 112 under the heading: “Objects in the area around the pedals” and at page 189 under the heading: “Carpets/floor mats,” the paragraph that begins: “Only use floor mats ...” should be disregarded and the following language should be read in lieu thereof: “The manufacturer of your vehicle recommends that you use floor mats that have been identified by it as appropriate for use in your vehicle and that can be properly fixed in place.”
8. At page 119, under the heading: “Have maintenance carried out,” the sentence beginning, “Have the maintenance carried out ...” should be disregarded and the following text should be read in lieu thereof:

“MINI recommends that you have the maintenance carried out by your service center.”

9. At page 152, under the heading “Pressure specifications,” the sentence beginning, “The inflation pressures apply to the tire sizes approved ... .” should be disregarded.
10. At page 159, under the heading: “Approved wheels and tires,” the term “Approved” should be disregarded and in lieu thereof, the term “Recommended” should be read in its place. In addition, the text of that section should be disregarded and the following text should be read in lieu thereof:

The manufacturer of your vehicle strongly suggests that you use wheels and tires that have been recommended by the vehicle manufacturer for your vehicle type; otherwise, for example, despite having the same official size ratings, variations can lead to body contact and with it, the risk of severe accidents.

The manufacturer of your vehicle does not evaluate non-recommended wheels and tires to determine if they are suitable for use on your vehicle.

11. At page 165, under the heading “Hood,” the sentence beginning, “If you are unfamiliar” should be disregarded.
12. At page 169, under the heading: “Service and Warranty Information Booklet for US Models and Warranty and Service Guide Booklet for Canadian Models,” the second paragraph should be disregarded and the following text read in lieu thereof:

The manufacturer of your vehicle recommends that you have maintenance and repair performed by your MINI dealer’s service center or another service center or repair shop that employs trained personnel that can perform maintenance and repair work on your vehicle in accordance with MINI specifications. The manufacturer of your vehicle recommends that you maintain records of all maintenance and repair work performed on your vehicle.

13. At page 179, under the “Battery replacement” section, the text should be disregarded and in lieu thereof the following text should be read:

Use of recommended vehicle batteries

The manufacturer of your vehicle recommends that you use vehicle batteries that it has tested and recommends for use in your vehicle; otherwise the vehicle could be damaged and systems or functions may not be fully available.

After a battery replacement, the manufacturer of your vehicle recommends that you have the battery registered on your vehicle by a service center to ensure that all comfort functions are fully available, and that any “check control” messages of these comfort functions are no longer displayed.

# CONTENTS

The fastest way to find information on a particular topic or item is by using the index, refer to page 210.

6 Notes

## AT A GLANCE

12 Cockpit

## CONTROLS

20 Opening and closing  
35 Adjusting  
43 Transporting children safely  
48 Driving  
58 Displays  
66 Lamps  
71 Safety  
81 Driving stability control systems  
85 Driving comfort  
88 Climate  
94 Interior equipment  
104 Storage compartments

## DRIVING TIPS

110 Things to remember when driving  
114 Loading  
118 Saving fuel

## ENTERTAINMENT

122 Radio MINI Boost CD

## COMMUNICATION

136 Telephone

## MOBILITY

148 Refueling  
150 Fuel  
152 Wheels and tires  
164 Engine compartment  
166 Engine oil  
168 Coolant  
169 Maintenance  
171 Replacing components  
181 Breakdown assistance  
186 Care  
191 Indicator/warning lamps

## REFERENCE

206 Technical data  
210 Everything from A to Z

# NOTES

## USING THIS OWNER'S MANUAL

The fastest way to find information on a particular topic is by using the index.

An initial overview of the vehicle is provided in the first chapter.

### Additional sources of information

Should you have any questions, your service center will be glad to advise you at any time.

Information on MINI, e.g., on technology, is available on the Internet: [www.mini.com](http://www.mini.com)

Information about MINI, e.g., on technology, is available on the Internet: [www.miniusa.com](http://www.miniusa.com)

## SYMBOLS

 Indicates precautions that must be followed precisely in order to avoid the possibility of personal injury and serious damage to the vehicle.

◀ Marks the end of a specific item of information.

"..." Identifies radio display texts used to select individual functions.

>...< Verbal instructions to use with the voice operation system.

>>...<< Identifies the answers generated by the voice operation system.

 Refers to measures that can be taken to help protect the environment.

### Symbols on vehicle components

 Indicates that you should consult the relevant section of this Owner's Manual for information on a particular part or assembly.

## VEHICLE EQUIPMENT

The manufacturer of your MINI is the Bayerische Motoren Werke Aktiengesellschaft, BMW AG.

This Owner's Manual describes all models, all series equipment, as well as country-specific and special equipment offered in the model series. Therefore, this Owner's Manual also describes and depicts equipment that may not be contained in your vehicle because of the selected special equipment or country version, for example.

This also applies to safety-related functions and systems.

For options and equipment not described in this Owner's Manual, please refer to the Supplementary Owner's Manuals.

## STATUS OF THIS OWNER'S MANUAL AT TIME OF PRINTING

The manufacturer of your vehicle pursues a policy of constant development that is conceived to ensure that our vehicles continue to embody the highest quality and safety standards. In rare cases, therefore, the features described in this Owner's Manual may differ from those in your vehicle.

## FOR YOUR OWN SAFETY

### Warranty

Your vehicle is technically configured for the operating conditions and registration requirements applying in the country of first delivery — homologation. If your vehicle is to be operated in a different country it might be neces-



sary to adapt your vehicle to potentially differing operating conditions and permit requirements. If your vehicle does not comply with the homologation requirements in a certain country you cannot lodge warranty claims for your vehicle there. Further information can be obtained from your Service Center.

### Maintenance and repairs

Advanced technology, e.g., the use of modern materials and high-performance electronics, requires suitable maintenance and repair methods.

Therefore, have this work performed only by a MINI service center or a workshop that works according to MINI repair procedures with appropriately trained personnel.

If this work is not carried out properly, there is the danger of subsequent damage and related safety hazards.

### Parts and accessories

For your own safety, it is recommended that you use genuine parts and accessories approved by MINI. When you purchase accessories tested and approved by MINI and Genuine MINI Parts, you simultaneously acquire the assurance that they have been thoroughly tested by MINI to ensure optimum performance when installed on your vehicle. MINI warrants these parts to be free from defects in material and workmanship. MINI will not accept any liability for damage resulting from installation of parts and accessories not approved by MINI. MINI cannot test every product made by other manufacturers to verify if it can be used on a MINI safely and without risk to either the vehicle, its operation, or its occupants. Genuine MINI Parts, MINI Accessories and other products approved by MINI, together with professional advice on using these items, are available from all MINI centers. Installation and operation of non MINI approved accessories such as alarms, radios, amplifiers, radar detectors, wheels, suspension components, brake dust shields, telephones,

including operation of any mobile phone from within the vehicle without using an externally mounted antenna, or transceiver equipment, for instance, CBs, walkie-talkies, ham radios or similar accessories, may cause extensive damage to the vehicle, compromise its safety, interfere with the vehicle's electrical system or affect the validity of the MINI Limited Warranty. See your MINI center for additional information. Maintenance, replacement, or repair of the emission control devices and systems may be performed by any automotive repair establishment or individual using any certified automotive part.

### California Proposition 65 Warning

California laws require us to state the following warning:

Engine exhaust and a wide variety of automobile components and parts, including components found in the interior furnishings in a vehicle, contain or emit chemicals known to the State of California to cause cancer and birth defects and reproductive harm. In addition, certain fluids contained in vehicles and certain products of component wear contain or emit chemicals known to the State of California to cause cancer and birth defects or other reproductive harm. Battery posts, terminals and related accessories contain lead and lead compounds. Wash your hands after handling. Used engine oil contains chemicals that have caused cancer in laboratory animals. Always protect your skin by washing thoroughly with soap and water.

### Service and warranty

We recommend that you read this publication thoroughly. Your vehicle is covered by the following warranties:

- ▶ New Vehicle Limited Warranty.
- ▶ Rust Perforation Limited Warranty.
- ▶ Federal Emissions System Defect Warranty.
- ▶ Federal Emissions Performance Warranty.

- ▷ California Emission Control System Limited Warranty.

Detailed information about these warranties is listed in the Service and Warranty Information Booklet for US models or in the Warranty and Service Guide Booklet for Canadian models.

Your vehicle has been specifically adapted and designed to meet the particular operating conditions and homologation requirements in your country and continental region in order to deliver the full driving pleasure while the vehicle is operated under those conditions. If you wish to operate your vehicle in another country or region, you may be required to adapt your vehicle to meet different prevailing operating conditions and homologation requirements. You should also be aware of any applicable warranty limitations or exclusions for such country or region. In such case, please contact Customer Relations for further information.

## Maintenance

Maintain the vehicle regularly to sustain the road safety, operational reliability and the New Vehicle Limited Warranty.

Specifications for required maintenance measures:

- ▷ MINI Maintenance system
- ▷ Service and Warranty Information Booklet for US models
- ▷ Warranty and Service Guide Booklet for Canadian models

If the vehicle is not maintained according to these specifications, this could result in serious damage to the vehicle. Such damage is not covered by the MINI New Vehicle Limited Warranty.

## DATA MEMORY

Numerous electronic components in your vehicle contain data memories that store technical information on the vehicle condition, events

and faults, either temporarily or permanently. This technical information generally documents the state of a component, a module, a system or the environment:

- ▷ Operating conditions of system components, such as filling levels.
- ▷ Status messages from the vehicle and its individual components, such as wheel rpm/speed, motion delay, transverse acceleration.
- ▷ Malfunctions and defects in important system components, such as lights and brakes.
- ▷ Vehicle responses to special driving situations, such as airbag deployment, use of the stability control systems.
- ▷ Ambient conditions, such as the temperature.

These data are of a technical nature only and are used to detect and eliminate faults and to optimize vehicle functions. Travel profiles of routes driven with the vehicle cannot be created from these data. If services are used, for instance in the event of repairs, service processes, warranty cases, quality assurance, etc., this technical information can be read out from the event and fault data memories by service personnel, including the manufacturer, using special diagnosis tools. This service personnel can provide you with more information if needed. After troubleshooting, the information in the fault memory is cleared or overwritten continuously.

Situations are conceivable during the use of the vehicle in which these technical data could become associated with a specific person in combination with other information, such as an accident report, damage to the vehicle, witness accounts, etc., possibly with the involvement of an authorized expert.

Additional functions that are contractually agreed with the customer, such as vehicle localization in the event of an emergency, permit the transfer of certain vehicle data out of the vehicle.

## EVENT DATA RECORDER EDR

This vehicle is equipped with an event data recorder EDR. The main purpose of an EDR is to record, in certain crash or near crash-like situations, such as an air bag deployment or hitting a road obstacle, data that will assist in understanding how a vehicle's systems performed. The EDR is designed to record data related to vehicle dynamics and safety systems for a short period of time, typically 30 seconds or less.

The EDR in this vehicle is designed to record such data as:

- ▶ How various systems in your vehicle were operating.
- ▶ Whether or not the driver and passenger safety belts were fastened.
- ▶ How far, if at all, the driver was depressing the accelerator and/or brake pedal.
- ▶ How fast the vehicle was traveling.

These data can help provide a better understanding of the circumstances in which crashes and injuries occur.

EDR data are recorded by your vehicle only if a nontrivial crash situation occurs; no data are recorded by the EDR under normal driving conditions and no personal data, e.g., name, gender, age, and crash location, are recorded.

However, other parties, such as law enforcement, could combine the EDR data with the type of personally identifying data routinely acquired during a crash investigation.

To read data recorded by an EDR, special equipment is required, and access to the vehicle or the EDR is needed. In addition to the vehicle manufacturer, other parties, such as law enforcement, that have the special equipment, can read the information if they have access to the vehicle or the EDR.

## REPORTING SAFETY DEFECTS

### For US customers

The following only applies to vehicles owned and operated in the US.

If you believe that your vehicle has a defect which could cause a crash or could cause injury or death, you should immediately inform the National Highway Traffic Safety Administration NHTSA, in addition to notifying BMW of North America, LLC, P.O. Box 1227, Westwood, New Jersey 07675-1227, Telephone 1-800-831-1117.

If NHTSA receives similar complaints, it may open an investigation, and if it finds that a safety defect exists in a group of vehicles, it may order a recall and remedy campaign.

However, NHTSA cannot become involved in individual problems between you, your dealer, or BMW of North America, LLC.

To contact NHTSA, you may call the Vehicle Safety Hotline toll-free at 1-888-327-4236 (TTY: 1-800-424-9153); go to <http://www.safercar.gov>; or write to: Administrator, NHTSA, 400 Seventh Street, SW., Washington, DC 20590. You can also obtain other information about motor vehicle safety from <http://www.safercar.gov>

### For Canadian customers

Canadian customers who wish to report a safety-related defect to Transport Canada, Defect Investigations and Recalls, may telephone the toll-free hotline 1-800-333-0510. You can also obtain other information about motor vehicle safety from <http://www.tc.gc.ca/roadsafety>.



**WATCH ME.**

**AT A GLANCE**

**CONTROLS**

**DRIVING TIPS**

**ENTERTAINMENT**

**COMMUNICATION**

**MOBILITY**

**REFERENCE**

# COCKPIT

## VEHICLE EQUIPMENT

This chapter describes all series equipment as well as country-specific and special equipment offered for this model series. Therefore, it also describes equipment that may not be found in your vehicle, for instance due to the selected

special equipment or the country version. This also applies to safety-related functions and systems.

When using the features and systems described here, adhere to local regulations.

## ALL AROUND THE STEERING WHEEL

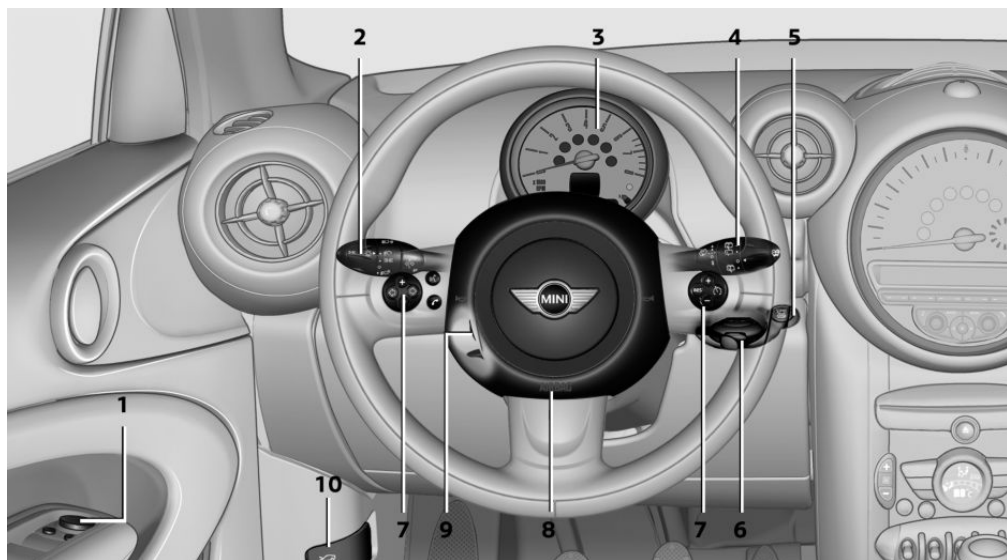

**1** Setting the exterior mirror, folding it in and out [40](#)



Power windows, front [33](#)



MINI Countryman: power windows, rear [33](#)



MINI Countryman: safety switch for rear power windows [34](#)

**2**  Parking lights [66](#)



Low beams [66](#)

















Automatic headlamp control [66](#)



Adaptive Light Control [68](#)



Turn signal [51](#)

-  High-beams [51](#)  
 Headlight flasher [51](#)  
 Roadside parking lights [67](#)  
 Computer [59](#)
- 3** Tachometer [59](#)  
 Instrument lighting [69](#)  
 Resetting the trip odometer [58](#)
- 4**  Washer/wiper system [52](#)
- 5**  Start/stop the engine and switch the ignition on/off [48](#)
- 6** Ignition lock [48](#)
- 7** Steering wheel buttons, right  
 Resuming cruise control [86](#)  
 Storing the speed and accelerating or slowing down [86](#)  
 Activating/deactivating cruise control [85](#)
- Steering wheel buttons, left  
 Volume  
 Telephone [136](#)  
 Change the radio station  
 Select a music track  
 Scroll through the redial list
- 8** Horn, the entire surface  
**9** Adjust the steering wheel [42](#)  
**10** Releasing the hood [165](#)

## DISPLAYS

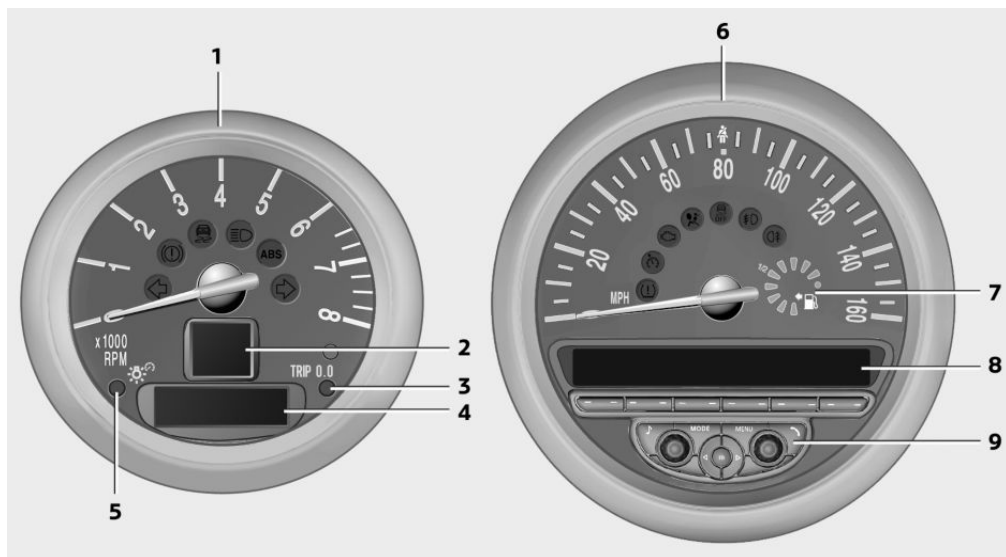

- 1 Tachometer 59  
with indicator and warning lights 15
- 2 Display for
  - ▷ Current speed 58
  - ▷ Indicator/warning lights 15
- 3 Resetting the trip odometer 58
- 4 Display for
  - ▷ Steptronic transmission position 55
  - ▷ On-board computer 59
  - ▷ Service requirements 63
  - ▷ Odometer and trip odometer 58
- 5 Instrument lighting 69
- 6 Speedometer with indicator and warning lights 15
  - ▷ Flat Tire Monitor 74
  - ▷ Tire Pressure Monitor 76
  - ▷ Settings and information 60
  - ▷ Personal Profile settings 20
- 7 Fuel gauge 59
- 8 Radio display
- 9 Radio Radio MINI Boost CD 122



## INDICATOR/WARNING LIGHTS

### The concept

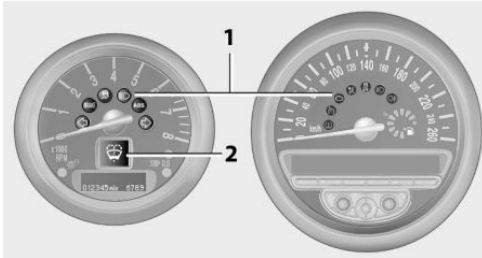

The indicator and warning lights can light up in a variety of combinations and colors in display area 1 or 2.

Several of the lights are checked for proper functioning when the engine is started or the ignition is switched on, and light up briefly.

### What to do in case of a malfunction

A list of all indicator and warning lights, as well as notes on possible causes of malfunctions and on how to respond, refer to page [191](#)

## ALL AROUND THE CENTER CONSOLE

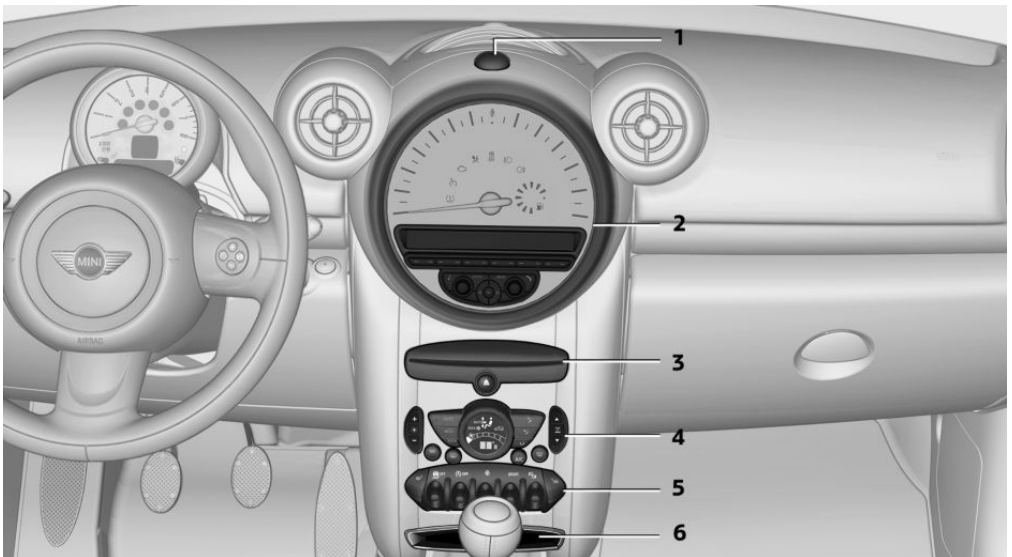

- |  |  |
|--|--|
| 1 Hazard warning system                                    | 4 Air conditioning, automatic climate control <a href="#">89</a> |
| 2 Speedometer with Radio MINI Boost CD <a href="#">122</a> | 5 Buttons on the center console                                  |
| 3 CD drive   |  |



Seat heating 37



Central locking, inside 25



Front fog lamps 69



Sport button 83



Driving stability control systems

DSC Dynamic Stability Control 81

DTC Dynamic Traction Control 82

6 Storage compartment

## ALL AROUND THE HEAD-LINER

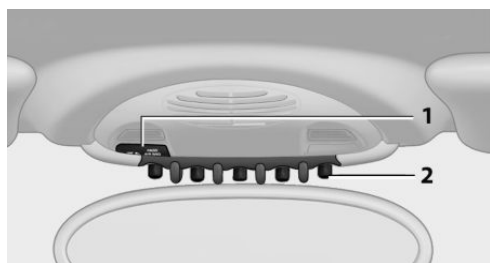

1 Indicator/warning lights for the front passenger airbags 73

2 Reading lights 70



Ambient lighting color 70



Glass sunroof, electrical 31



Interior lights 69

## ALL AROUND THE SHIFT/SELECTOR LEVER

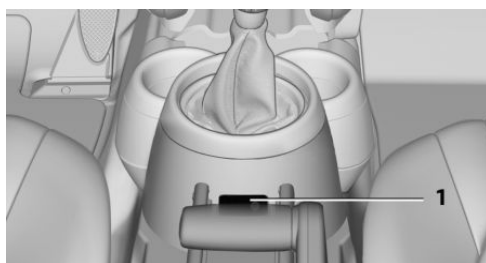

1 AUX-IN port 130

USB audio interface 131





**HANDLE ME.**

**AT A GLANCE**

**CONTROLS**

**DRIVING TIPS**

**ENTERTAINMENT**

**COMMUNICATION**

**MOBILITY**

**REFERENCE**

# OPENING AND CLOSING

## VEHICLE EQUIPMENT

This chapter describes all series equipment as well as country-specific and special equipment offered for this model series. Therefore, it also describes equipment that may not be found in your vehicle, for instance due to the selected special equipment or the country version. This also applies to safety-related functions and systems.

When using the features and systems described here, adhere to local regulations.

## REMOTE CONTROL/KEY

### Buttons on the remote control

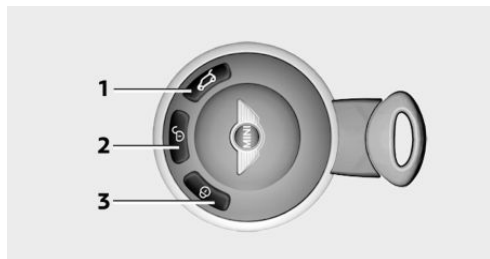

- 1 Opening tailgate
- 2 Unlocking
- 3 Locking

### General information

Each remote control contains a rechargeable battery that is automatically recharged when it is in the ignition lock while the car is being driven. Use each remote control at least twice a year for longer road trips in order to maintain the batteries' charge status.

In vehicles equipped with Comfort Access, the remote control contains a replaceable battery, refer to page 30.

The settings called up and implemented when the vehicle is unlocked depend on which remote control is used to unlock the vehicle, Personal Profile, refer to page 20.

In addition, information about service requirements is stored in the remote control, Service data in the remote control, refer to page 169.

### Integrated key

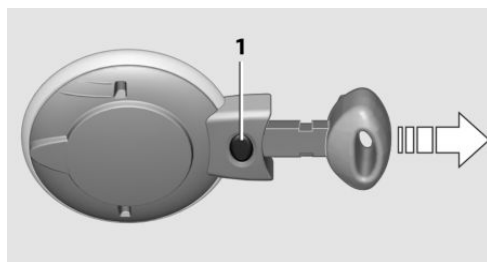

Press button 1 to unlock the key.

The integrated key fits the following locks:

- ▷ Driver's door, refer to page 24.

### New remote controls

You can obtain new remote controls from your service center.

### Loss of the remote controls

Lost remote controls can be blocked by your service center.

## PERSONAL PROFILE

### The concept

You can set several of your vehicle's functions to suit your personal needs and preferences.

- ▷ Through Personal Profile, most of these settings are stored for the remote control currently in use.

- ▷ While the vehicle is being unlocked, the remote control is recognized and the settings stored with it are called up and implemented.
- ▷ Your personal settings will be recognized and called up again even if the vehicle has been used in the meantime by someone else with another remote control.
- ▷ The individual settings are stored for no more than three remote controls.

### Personal Profile settings

The following functions and settings can be stored in a profile.

More information on the settings can be found under:

- ▷ Response of the central locking system when the car is being unlocked, refer to page 22.
- ▷ Automatic locking of the vehicle, refer to page 26.
- ▷ Triple turn signal activation, refer to page 51.
- ▷ Settings for the displays in the speedometer and tachometer:
  - ▷ 12h/24h clock format, refer to page 61.
  - ▷ Date format, refer to page 61.
  - ▷ Units of measure for fuel consumption, distance covered/remaining distances, and temperature, refer to page 61.
- ▷ Light settings:
  - ▷ Headlamp courtesy delay feature, refer to page 68.
  - ▷ Daytime running lights, refer to page 67.
- ▷ Automatic climate control, refer to page 90: AUTO program, activating/deactivating the cooling function, setting the temperature, air volume, and air distribution.
- ▷ Entertainment:

- ▷ Last entertainment source.
- ▷ Radio MINI Boost CD:
  - Tone settings, refer to page 124.
  - Volume, refer to page 124.

## CENTRAL LOCKING SYSTEM

### The concept

The central locking system becomes active when the driver's door is closed.

The system simultaneously engages and releases the locks on the following:

- ▷ Doors.
- ▷ Tailgate.
- ▷ Fuel filler flap.

### Operating from the outside

- ▷ Via the remote control.
- ▷ Via the door lock.
- ▷ In cars with Comfort Access, via the door handles on the driver's and front passenger sides.

The following takes place simultaneously when locking/unlocking the vehicle via the remote control:

- ▷ Depending on the vehicle equipment, the anti-theft protection is switched on and off as well. The anti-theft protection makes it impossible to unlock the doors using the lock buttons or door handles.
- ▷ The welcome lamps, interior lamps, and ambient lighting are switched on and off.
- ▷ The alarm system is armed or disarmed, refer to page 30.

### Operating from the inside

Via the switch/button for the central locking system, refer to page 25.

In an accident of the necessary severity, the central locking system unlocks automatically.

The hazard warning system and interior lamps come on.

## OPENING AND CLOSING: FROM THE OUTSIDE

### Using the remote control

#### General information

 Take the remote control with you. People or animals left unattended in a parked vehicle can lock the doors from the inside. Always take the remote control with you when leaving the vehicle so that the vehicle can then be opened from the outside. ◀

#### Unlocking

 Press the button. The vehicle is unlocked.

The welcome lamps and interior lamps are switched on.

You can set how the vehicle is to be unlocked. The setting is stored for the remote control currently in use.

1. Switch on the ignition, refer to page 48.
2. Press the button on the turn indicator lever repeatedly until "SET/INFO" is displayed.

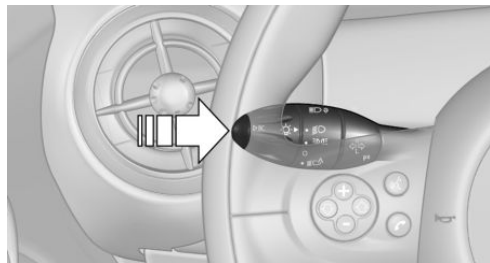

3. Press and hold the button in the turn indicator lever until the display changes.

4. Press the button in the turn indicator lever repeatedly until the symbol and "SET" are displayed.

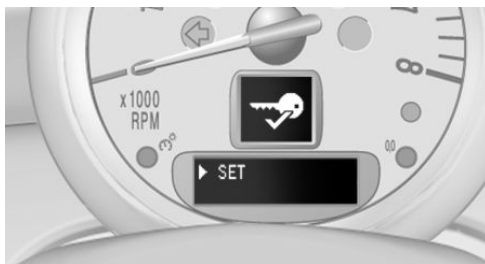

5. Press and hold the button in the turn indicator lever until the display changes.
6. Press the button in the turn indicator lever repeatedly until the symbol shown is displayed, arrow.

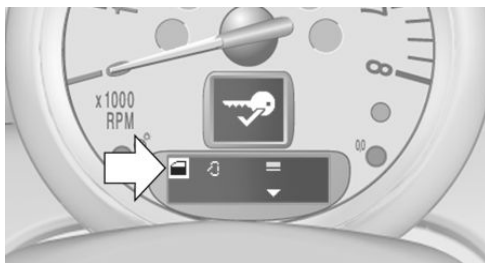

7. Press and hold the button in the turn indicator lever until the display changes.
8. Press the button in the turn indicator lever repeatedly to select the following settings:



Selected setting:

 Pressing the button on the remote control once unlocks only the driver's door and the fuel filler flap. Pressing twice unlocks the entire vehicle.



Selected setting:



 Pressing the button on the remote control once unlocks the entire vehicle.

9. Press and hold the button in the turn indicator lever until the display changes. The setting is stored for the remote control currently in use.

### Convenient opening

 Press and hold the button on the remote control.

The power windows are opened. Depending on the vehicle equipment, the glass sunroof is raised.

Convenient closing with the remote control is not possible.

### Locking

 Press the button.

#### Locking from the outside

Do not lock the vehicle from the outside if there are people in it, as the vehicle cannot be unlocked from inside without special knowledge. ◀

### Setting the confirmation signals

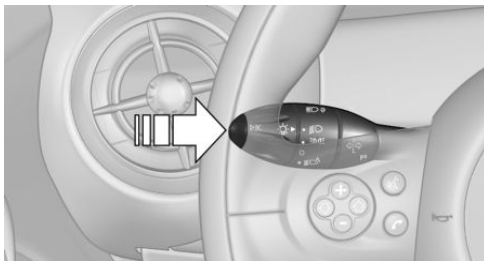

Have unlocking or locking of the vehicle confirmed.

1. Switch on the ignition, refer to page 48.
2. Press the button on the turn indicator lever repeatedly until "SET/INFO" is displayed.



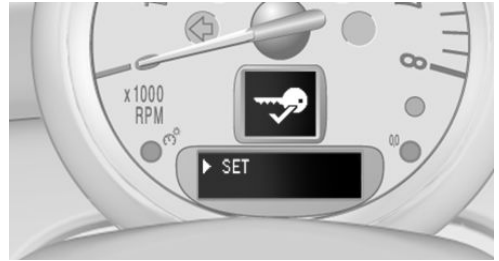

3. Press and hold the button until the display changes.
4. Press the button repeatedly until the symbol and "SET" are displayed.

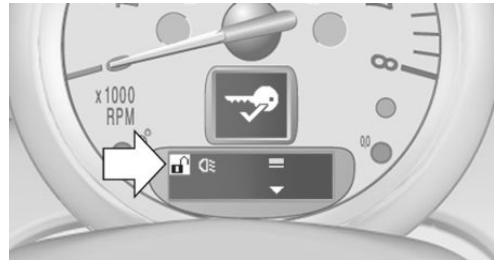

5. Press and hold the button until the display changes.
6. Press the button to select, arrow:
  - ▶  Confirmation signal during unlocking
  - ▶  Confirmation signal during locking



7. Press and hold the button until the display changes.
8. Press the button to select:
  - ▶  The hazard warning system flashes during unlocking/locking.
  - ▶  An acoustic signal sounds during unlocking/locking.
  - ▶  The hazard warning system lights up and an acoustic signal sounds during unlocking/locking.

▷ **off**

The function is deactivated.

9. Press and hold the button until the display changes. The setting is stored.

### Switching on the interior lamps

When the vehicle is locked:

 Press the button.

You can also use this function to locate your vehicle in parking garages, etc.

### Unlocking the tailgate

 Press the button for approx. 1 second and then release it.

### Malfunctions

The function of the remote control may be impaired by local radio waves. If this occurs, unlock and lock the vehicle at the door lock with the integrated key.

If it should become impossible to lock the vehicle with a remote control, the battery in the remote control is discharged. Use this remote control on an extended trip to recharge the battery, refer to page 20.

### For US owners only

The transmitter and receiver units comply with part 15 of the FCC/Federal Communication Commission regulations. Operation is governed by the following:

FCC ID:  
LX8766S  
LX8766E  
LX8CAS

Compliance statement:

This device complies with part 15 of the FCC Rules. Operation is subject to the following two conditions:

- ▷ This device may not cause harmful interference, and
- ▷ this device must accept any interference received, including interference that may cause undesired operation.

Any unauthorized modifications or changes to these devices could void the user's authority to operate this equipment.

### Using the door lock

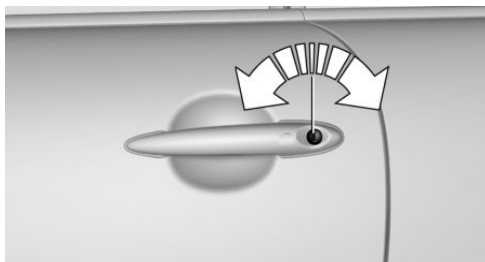

Sets how the vehicle is to be unlocked, refer to page 22.

In some vehicle equipment versions, only the driver's door can be unlocked and locked via the door lock.



Locking from the outside

Do not lock the vehicle from the outside if there are people in it, as the vehicle cannot be unlocked from inside without special knowledge. ◀

### Unlocking the doors and tailgate at once

To lock all doors, the fuel filler flap, and the tailgate at once:

1. With the doors closed, lock the vehicle using the button for the central locking system in the interior, refer to page 25.
2. Unlock and open the driver's or front passenger door, refer to page 25.
3. To lock the vehicle:

- ▷ Lock the driver's door using the integrated key in the door lock, or
- ▷ Press down the lock button of the front passenger door and close the door from the outside.

### Convenient opening and closing

In vehicles with an alarm system or Comfort Access, the windows and the glass sunroof can be operated via the door lock.

### Opening/closing

Turn the key to the unlock or lock position and hold it there.

-  Keep the closing area clear
- Watch during the opening and closing process to be sure that no one becomes trapped. Releasing the key stops the motion. ◀

### Manual operation

If an electrical malfunction occurs, the driver's door can be unlocked or locked by turning the integrated key to the end positions of the door lock.

## OPENING AND CLOSING: FROM THE INSIDE

Operation via

- ▷ Switch in the center console:

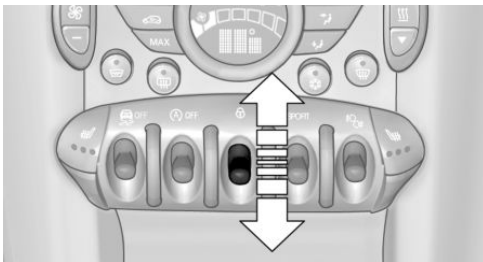

- ▷ Button in the driver's or front passenger door:

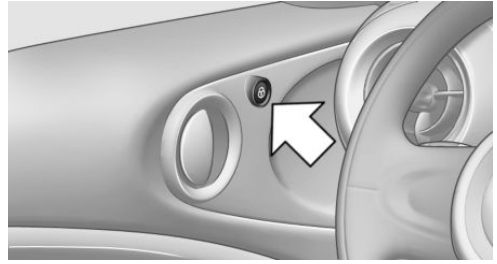

The graphic shows the button in the MINI Pace-man as an example.

The switch or the buttons can be used to lock or unlock the doors and tailgate when the doors are closed, but they are not theft-protected. The fuel filler flap remains unlocked.

### Unlocking and opening doors

- ▷ Using the switch or the buttons for the central locking system, unlock all of the doors at once and then pull the door opener above the armrest, or
- ▷ Pull the door handle on each door twice: the door is unlocked the first time and opened the second time.

### Locking

- ▷ Press the switch/button or
- ▷ Push down the lock button of a door. To avoid locking yourself out by accident, the driver's door cannot be locked at the lock button while the door is open.

### Automatic locking

In addition, it is possible to set the situations in which the vehicle locks. The setting is stored for the remote control in use.

1. Switch on the ignition, refer to page 48.
2. Press the button on the turn indicator lever repeatedly until "SET/INFO" is displayed.

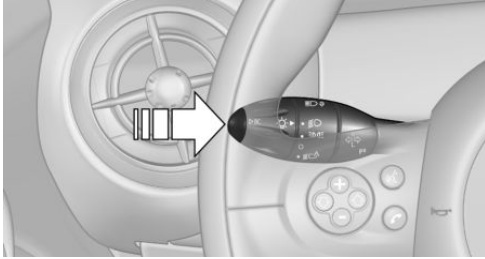

3. Press and hold the button until the display changes.
4. Press the button repeatedly until the symbol and "SET" are displayed.

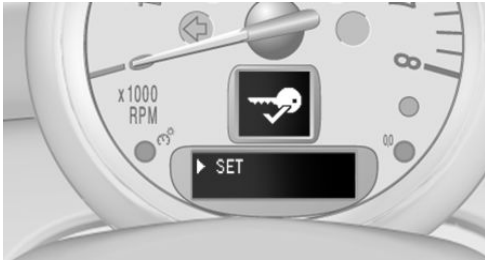

5. Press and hold the button until the display changes.
6. Press the button repeatedly until the symbol shown is displayed, arrow.

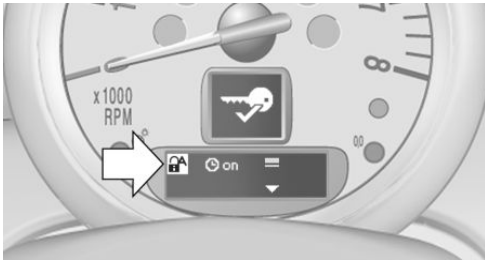

7. Press and hold the button until the display changes.
8. Press the button to select:
  - ▷ on  
The central locking system locks automatically after some time if no door is opened.
  - ▷ on  
The vehicle locks automatically after you drive away.
  - ▷ →  
The vehicle locks automatically after a short period of time if a door is not opened or after you drive away.
  - ▷ off  
The central locking system remains unlocked.
9. Press and hold the button until the display changes. The setting is stored.

### TAILGATE

#### Opening

The tailgate pivots back and up when it opens. Ensure that adequate clearance is available before opening.



Provide edge protection

Sharp or angular objects can hit the rear window while driving and damage the heating wires of the rear window. Provide edge protection. ◀

Only drive with the tailgate fully closed; otherwise, the tail lamps will be hidden from view and driving safety will be compromised.

In some market-specific versions, the tailgate can only be unlocked using the remote control if the vehicle was unlocked first.

### Opening from the inside

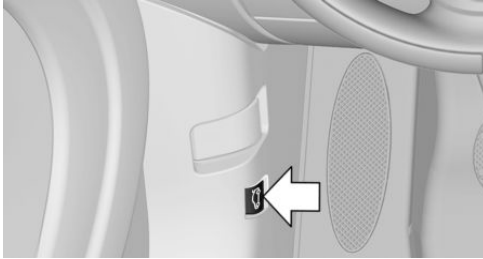

Press the button on the driver's footwell.

### MINI Countryman

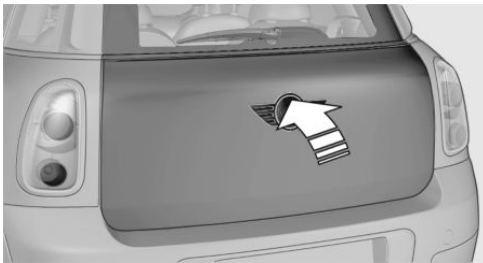

Press the top half of the MINI emblem, arrow, or

 Press the button on the remote control for approx. 1 second and release. The tailgate is unlocked.

### MINI Paceman

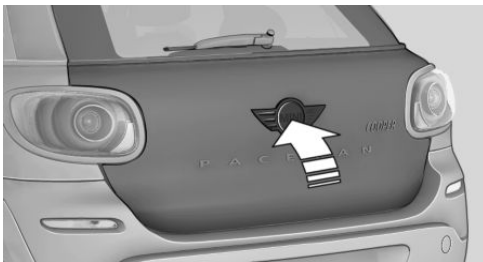



Press the top half of the MINI emblem, arrow, or

 Press the button on the remote control for approx. 1 second and release. The tailgate is unlocked.

### Closing

 Keep the closing area clear  
Make sure that the closing area of the tailgate is clear; otherwise, injuries or damage may result. ◀

 Take the remote control with you  
Always take the remote control with you when leaving the vehicle and do not place it in the cargo area; otherwise, the remote control may be locked into the vehicle when the tailgate is closed. ◀

 Move the cover into position  
When closing, ensure that the cargo cover is resting on the rubber buffers of the securing straps; otherwise, damage may occur when closing the tailgate. ◀

### MINI Countryman



Recessed grips on the inside trim of the tailgate can be used to conveniently pull down the tailgate.

## MINI Paceman



Recessed grips on the inside trim of the tailgate can be used to conveniently pull down the tailgate.

## COMFORT ACCESS

### The concept

The vehicle can be accessed without activating the remote control. All you need to do is to have the remote control with you, e.g., in your jacket pocket. The vehicle automatically detects the remote control when it is nearby or in the passenger compartment.

Comfort Access supports the following functions:

- ▷ Unlocking/locking of the vehicle.
- ▷ Unlocking of the tailgate separately.
- ▷ Starting the engine.

### Functional requirements

- ▷ There are no external sources of interference in the vicinity.
- ▷ To lock the vehicle, the remote control must be located outside of the vehicle.
- ▷ The next unlocking and locking cycle is not possible until after approx. 2 seconds.
- ▷ The engine can only be started if the remote control is inside the vehicle.
- ▷ The doors and tailgate must be closed to operate the windows.

### Comparison with ordinary remote control

The functions can be controlled by pressing the buttons or via Comfort Access.

Notes on opening and closing, refer to page 20.

If you notice a brief delay while opening or closing the windows or glass sunroof, the system is checking whether a remote control is inside the vehicle. Repeat the opening or closing procedure, if necessary.

### Unlocking



Press button 1.

Depending on the setting, either only the driver's door or the entire vehicle is unlocked, refer to page 22.

Pressing the button again locks the entire vehicle again.

Convenient opening with the remote control, refer to page 23.

### Locking

Press button 1.

For Convenient closing, press and hold button 1.

The windows and, if applicable, the glass sunroof are closed in addition.

### Unlocking the tailgate separately

Press the top half of the MINI emblem.

This corresponds to pressing the following button on the remote control:  .

If a remote control accidentally left in the cargo area is detected in the locked vehicle after the tailgate is closed, the tailgate opens again slightly. The hazard warning system flashes and an acoustic signal sounds.

### Power windows and electrical glass sunroof

When the engine is switched off, the windows and the sunroof can be operated as long as neither the doors nor the tailgate are opened.

When the door and tailgate are closed again and the remote control is detected inside the vehicle, the windows and the sunroof can be operated again.

Insert the remote control into the ignition lock to be able to operate the windows and the sunroof while the engine is switched off and the doors are open.

### Switching on the radio ready state

Press the Start/Stop button to switch on the radio ready state, refer to page 48.

Do not depress the brake or the clutch; otherwise, the engine will start.

### Starting the engine

The engine can be started or the ignition can be switched on, refer to page 48, when a remote control is inside the vehicle. It is not necessary to insert a remote control into the ignition lock.

### Switching off the engine in cars with Steptronic transmission

The engine can only be switched off with the selector lever in position P, refer to page 55.

To switch off the engine with the selector lever in position N, the remote control must be inserted in the ignition lock.

### Before driving a vehicle with Steptronic transmission into a car wash

1. Insert the remote control into the ignition switch.
2. Depress the brake pedal.
3. Move the selector lever to position N.
4. Switch the engine off.

The vehicle can roll.

### Malfunction

The Comfort Access functions can be disturbed by local radio waves, such as by a mobile phone in the immediate vicinity of the remote control or when a mobile phone is being charged in the vehicle.

If this occurs, open or close the vehicle using the buttons on the remote control or use the integrated key in the door lock.

To start the engine afterward, insert the remote control into the ignition switch.

### Warning lights



The warning light in the instrument cluster lights up when you attempt to start the engine: the engine cannot be started.

The remote control is not in the vehicle or has a malfunction. Take the remote control with you inside the vehicle or have it checked. If necessary, insert another remote control into the ignition switch.



The warning lamp in the instrument cluster lights up while the engine is running: the remote control is no longer inside the vehicle.

After switching off the engine, the engine can only be started again within approx. 10 seconds if no door has been opened.



The indicator lamp lights up: replace the remote control battery.

## Replacing the battery

The remote control for Comfort Access contains a battery that will need to be replaced from time to time.

1. Remove the cover.

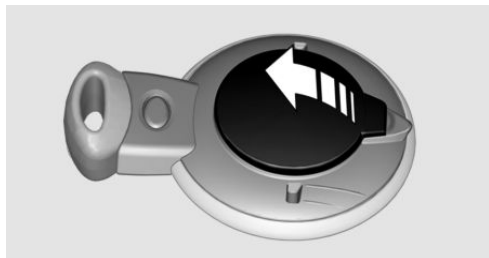

2. Insert a new battery with the positive side facing upwards.
3. Press the cover closed.

 Return used battery to a recycling center or to your service center.

## ALARM SYSTEM

### The concept

The enabled alarm system reacts to the following:

- ▷ Opening of a door, the hood or the tailgate.
- ▷ Movements inside the vehicle.
- ▷ Changes in the vehicle tilt, e.g., during attempts to steal a wheel or tow the car.
- ▷ Interruptions in battery voltage.

Depending on the market-specific version, the alarm system briefly signals unauthorized entry attempts by:

- ▷ By sounding an acoustic alarm.
- ▷ By switching on the hazard warning system.

## Arming and disarming the alarm system

### General information

When the vehicle is locked and unlocked, the alarm system is armed and disarmed at the same time.

### Door lock and armed alarm system

Unlocking via the door lock will trigger the alarm on some market-specific versions.

To stop this alarm, unlock the vehicle with the remote control or switch on the ignition.

### Tailgate with armed alarm system

The tailgate, refer to page 24, can also be opened when the alarm system is armed.

 Press the button on the remote control.

When you subsequently close the tailgate, it is again locked and monitored.

Unlocking via the door lock will trigger the alarm on some market-specific versions.

### Switching off the alarm

- ▷ Unlock the vehicle using the remote control, refer to page 22.
- ▷ Insert the remote control all the way into the ignition lock.
- ▷ With Comfort Access and if you are carrying the remote control with you, push the button on the door lock.

### Display on the tachometer

When the alarm system is being armed, all LEDs pulse like a heartbeat. One LED flashes after approx. 16 minutes.



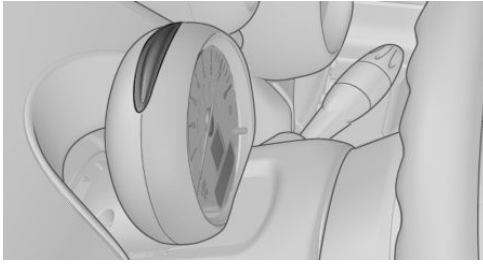

- ▷ LEDs pulse or LED flashes: system is armed.
- ▷ One LED flashes at short intervals: the doors, hood, or tailgate is not properly closed.  
Even if these are not closed fully, the remaining items are locked and the LEDs pulse after approx. 10 seconds for approx. 16 minutes; afterwards, one LED flashes. The interior motion sensor is not activated.
- ▷ The LEDs go out after the vehicle is unlocked: the vehicle has not been tampered with in the meantime.
- ▷ The LEDs flash after the vehicle is unlocked until the remote control is inserted in the ignition, but for no longer than approx. 5 minutes: the vehicle has been tampered with in the meantime.

### Panic mode

You can trigger the alarm system if you find yourself in a dangerous situation.



Press the button on the remote control for at least two seconds.

To switch off the alarm: press any button on the remote control.

### Tilt alarm sensor

The tilt of the vehicle is monitored.

The alarm system responds in situations such as attempts to steal a wheel or tow the car.

### Interior motion sensor

For the interior motion sensor to function properly, the windows and the glass sunroof must be closed.

### Avoiding unintentional alarms

The tilt alarm sensor and interior motion sensor can be switched off together, such as in the following situations:

- ▷ In duplex garages.
- ▷ During transport on car-carrying trains, at sea or on a trailer.
- ▷ When animals are to remain in the vehicle.

### Switching off the tilt alarm sensor and interior motion sensor

- ▷  Press the button on the remote control twice in succession.
- ▷ Lock the vehicle twice with the integrated key.

The LEDs flash in short succession for approx. 2 seconds. The tilt alarm sensor and interior motion sensor remain switched off until the vehicle is unlocked and locked again.

## GLASS SUNROOF, ELECTRICAL

### General information



Danger of pinching

Monitor the closing process and make sure that the closing path of the glass sunroof is clear; otherwise, injuries may result. ◀



Take the remote control with you

Take the remote control with you when leaving the vehicle so that children, for example, cannot operate the roof and injure themselves. ◀

Convenient operation via:

- ▷ Door lock, refer to page 24

- ▷ Comfort Access, refer to page 28

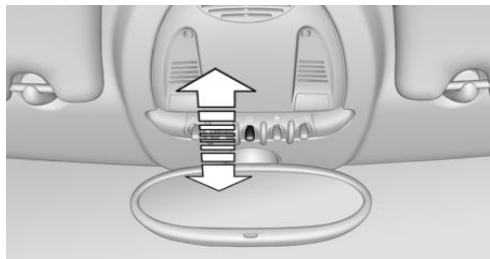

### Tilting the glass sunroof

MINI Countryman:

- ▷ Press the switch back to the resistance point and hold.  
Both glass sunroofs are raised.  
Releasing stops the motion.
- ▷ With the ignition switched on, press the switch back past the resistance point.  
Both closed glass sunroofs are raised fully.  
Pressing again stops the motion.

MINI Paceman:

- ▷ Press the switch back to the resistance point and hold.  
The front glass sunroof is raised.  
Releasing stops the motion.
- ▷ With the ignition switched on, press the switch back past the resistance point.  
The front glass sunroof is fully raised.  
Pressing again stops the motion.

### Opening, closing

MINI Countryman:

- ▷ In the raised position with the ignition switched on, press the switch back and hold.  
The front glass sunroof is opened. The rear glass sunroof is closed.  
Releasing stops the motion.

The same method is used to close the glass sunroof, in this case by pressing the switch forward.

The front glass sunroof remains in the raised position. The rear glass sunroof is raised. Pressing again closes both sunroofs completely.

MINI Paceman:

- ▷ In the raised position with the ignition switched on, press the switch back and hold.  
The front glass sunroof is opened.  
Releasing stops the motion.

The same method is used to close the glass sunroof, in this case by pressing the switch forward.

The front glass sunroof remains in the raised position. Pressing again closes the roof completely.

### Roller sunblind

The roller sunblind can be opened and closed separately from the glass sunroof.

### After a power failure

After a power failure, it could happen that the sunroof can only be raised. In this case, have the system initialized. The manufacturer of your MINI recommends having this work performed by the service center.

## POWER WINDOWS

### General information



Danger of pinching

Monitor the closing process and make sure that the closing path of the window is clear; otherwise, injuries may result. ◀



Take the remote control with you

Take the remote control with you when leaving the vehicle so that children, for example, cannot operate the power windows and injure themselves. ◀

If, after having been opened and closed a number of times in close succession, a window can only be closed, the system is overheated. Let the system cool down for several minutes with the ignition switched on or the engine running.

## Opening, closing

### Front windows



To open:

- ▶ Press the switch to the resistance point. The window opens while the switch is held.
- ▶ Press the switch beyond the resistance point. The window opens automatically in the radio ready state and higher.

Press again briefly to stop the opening procedure.

To close:

- ▶ Pull the switch to the resistance point. The window closes while the switch is held.
- ▶ Pull the switch beyond the resistance point. The window closes automatically.

Pressing the switch stops the motion.

### MINI Countryman: rear windows



To open:

- ▶ Press the switch to the resistance point. The window opens while the switch is held.
- ▶ Press the switch beyond the resistance point. The window opens automatically in the radio ready state and higher.

To close:

- ▶ Pull the switch to the resistance point. The window closes while the switch is held.
- ▶ Pull the switch beyond the resistance point. The window closes automatically.

Pressing the switch stops the motion.

### After the ignition is switched off

The windows can be operated for approx. 1 minute after the remote control is removed or the ignition is switched off.



Take the remote control with you

Take the remote control with you when leaving the vehicle so that children, for example, cannot operate the power windows and injure themselves. ◀

### Pinch protection system

If the closing force exceeds a specific value as a window closes, the closing action is interrupted.

The window reopens slightly.

 Danger of pinching even with pinch protection

Even with the pinch protection system, check that the window's closing path is clear; otherwise, the closing action may not stop in certain situations, e.g., if thin objects are present. ◀

 Do not use window accessories  
Do not install any accessories in the range of movement of the windows; otherwise, the pinch protection system will be impaired. ◀

### Closing without the pinch protection system

 Danger of pinching  
Monitor the closing process and make sure that the closing path of the window is clear; otherwise, injuries may result. ◀

If there is an external danger or, for example, if ice on the windows prevents a window from closing normally, the window can be closed manually.

1. Pull the switch past the resistance point and hold it there. Pinch protection is limited and the window reopens slightly if the closing force exceeds a certain value.
2. Pull the switch past the resistance point again within approx. 4 seconds and hold it there.

The window closes without pinch protection.

### MINI Countryman: safety switch



With the safety switch, the rear windows are prevented from being opened or closed via the switches in the rear passenger area, such as by children.

Press the button. The LED lights up if the safety function is switched on.

 Safety switch for rear operation  
Press the safety switch when transporting children in the rear; otherwise, injury may result if the windows are closed without supervision. ◀

# ADJUSTING

## VEHICLE EQUIPMENT

This chapter describes all series equipment as well as country-specific and special equipment offered for this model series. Therefore, it also describes equipment that may not be found in your vehicle, for instance due to the selected special equipment or the country version. This also applies to safety-related functions and systems.

When using the features and systems described here, adhere to local regulations.

## SITTING SAFELY

The ideal seating position can make a vital contribution to relaxed, fatigue-free driving.

The seating position plays an important role in an accident in combination with:

- Safety belts, refer to page 37
- Head restraints, refer to page 39.
- Airbags, refer to page 71.

## SEATS

### Note before adjusting

 Do not adjust the seat while driving  
Never attempt to adjust the driver's seat while driving. The seat could respond with unexpected movement and the ensuing loss of vehicle control could lead to an accident. ◀

 Do not incline the backrest too far to the rear

Do not incline the backrest on the front passenger side too far to the rear during driving. Otherwise, there is the danger of sliding under the

safety belt in an accident. This would eliminate the protection normally provided by the belt. ◀

### Front seat adjustment

#### Forward/backward



Pull the lever, arrow 1, and slide the seat into the desired position, arrows 2.

After releasing the lever, move the seat forward or back slightly to make sure it engages properly.

#### Height

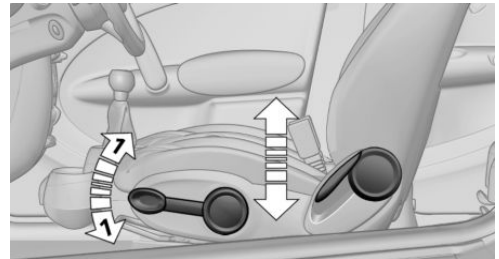

Pull the lever up or push it down repeatedly, arrows 1, until the desired height is reached, arrows 2.

#### Backrest

MINI Countryman:

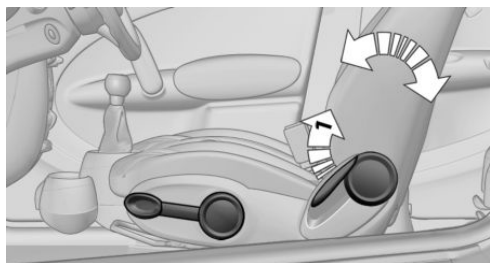

Pull the lever, arrow 1, and apply your weight to the backrest or lift it off, as necessary.

MINI Paceman:

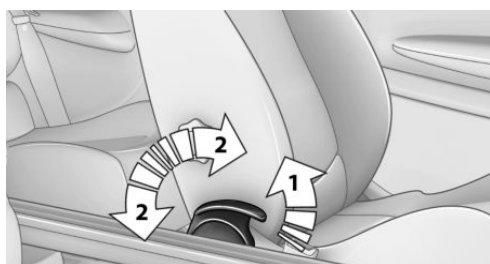

Pull the lever, arrow 1, and apply your weight to the backrest or lift it off, as necessary, arrows 2.

### Lumbar support

You can also adjust the contour of the backrest to obtain additional support in the lumbar region.

The upper hips and spinal column receive supplementary support to help you maintain a relaxed, upright sitting position.

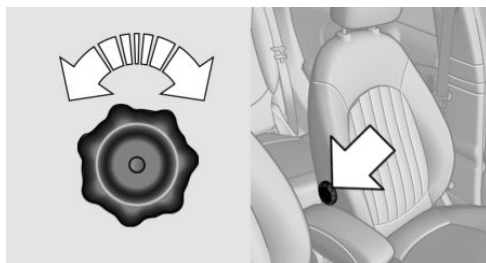

The graphic shows the MINI Countryman as an example.

Turn the wheel to increase or decrease the curvature.

### MINI Countryman: rear seat adjustment



Observe the following when adjusting

Do not adjust the rear seats during a trip; otherwise, there is a risk of passenger injury.

Make sure that the locking mechanisms of the rear seats engage properly. Otherwise the restraining effect of the safety belts during an accident could be reduced. ◀

### Forward/backward

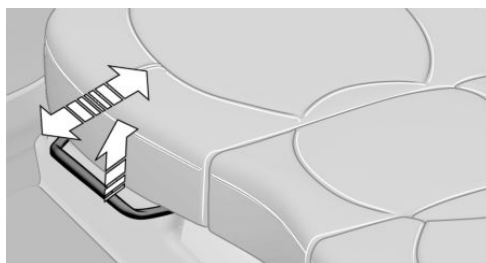

Pull the lever and slide the seat into the desired position.

Release the lever and move the seat slightly forward or back so that it engages properly.

### Backrest

Adjust the backrest tilt, refer to page 100.

## Seat heating

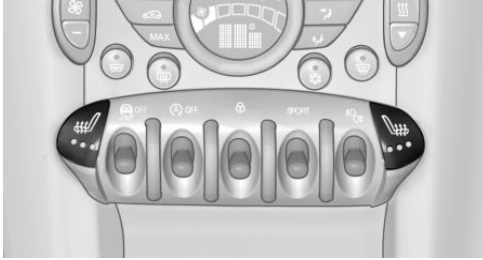

### Switching on

The temperature setting progresses one step through its control sequence each time you press the button. The maximum temperature is reached when three LEDs are lit.

If the trip is continued within approx. 15 minutes, the seat heating is activated automatically with the temperature set last.

The temperature is reduced, if need be, down to no heat in order to reduce the load on the battery. The LEDs remain lit.

### Switching off

Press the button longer.

## SAFETY BELTS

### Number of safety belts

Your vehicle has been fitted with four or five safety belts for the safety of you and your passengers.

However, they can only offer protection when adjusted correctly.

### Notes

Always make sure that safety belts are being worn by all occupants before driving away.

Although airbags enhance safety by providing added protection, they are not a substitute for safety belts.

The shoulder strap's anchorage point will be correct for adult seat occupants of every build if the seat is correctly adjusted.



One person per safety belt

Never allow more than one person to wear a single safety belt. Never allow infants or small children to ride on a passenger's lap. ◀



Putting on the belt

Lay the belt, without twisting, snugly across the lap and shoulders, as close to the body as possible. Make sure that the belt lies low around the hips in the lap area and does not press on the abdomen. Otherwise, the belt can slip over the hips in the lap area in a frontal impact and injure the abdomen.

The safety belt must not lie across the neck, rub on sharp edges, be routed over solid or breakable objects, or be pinched. ◀



Reduction of restraining effect

Avoid wearing clothing that prevents the belt from fitting properly, and pull the shoulder belt periodically to readjust the tension across your lap; otherwise, the retention effect of the safety belt may be reduced. ◀

### Buckling the belt

MINI Countryman:

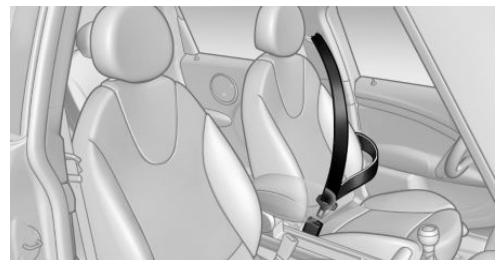

MINI Paceman:

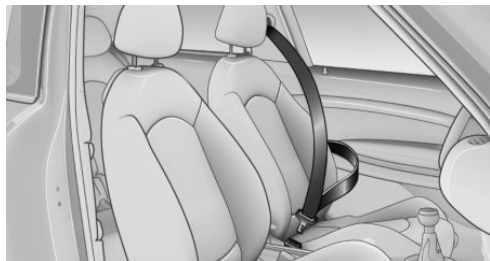

Make sure you hear the latch plate engage in the belt buckle.

The shoulder strap's anchorage point will be correct for adult seat occupants of every build if the seat is correctly adjusted, refer to page 35.

### Unbuckling the belt

1. Hold the belt firmly.
2. Press the red button in the belt buckle.
3. Guide the belt back into its reel.

### Securing the buckle tongues

If the front passenger seat is not occupied, slide the buckle tongue up to the belt stop knob with the clip.

When the outer rear seats are not occupied, the buckle tongues of the rear seats can be slid up to the cargo area trim with the clip.

This helps avoid annoying noises when driving.

### MINI Countryman: center safety belt of rear seat

The belt buckle embossed with the word CENTER is intended exclusively for use by passengers riding in the center position.

If the center safety belt in the rear is used, the backrests must be locked, refer to page 101.

The safety belt will not have a restraining effect if the backrest is not locked.

### Belt holder in the headliner

The holder for the safety belt is located in the headliner.



- 1 Opening for the safety belt
- 2 Holder for the small buckle tongue

Take the small buckle tongue out of the holder. Move both buckle tongues downward.

### Closing

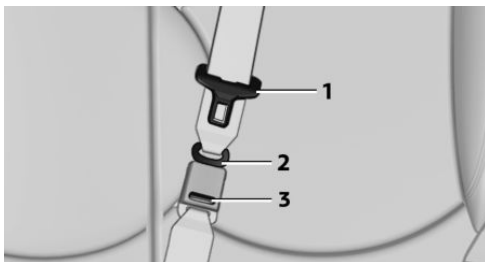

Insert the small buckle tongue 2 of the safety belt into the small belt buckle 3.

### Opening

Press the red button on the small belt buckle 3 with buckle tongue 1.

When the center safety belt is locked:

Press the red button 3 with the buckle tongue of the outer left safety belt.



## Putting on the belt



- 1 Large buckle tongue
- 2 Small buckle tongue
- 3 Small belt buckle
- 4 Large belt buckle

Buckle tongue 1 must be inserted in belt buckle 4. Make sure you hear the buckle tongue engage in the belt buckle.

Insert the buckle tongue into the belt buckle in such a way that the belt lies smoothly against the body of the buckled person and is not twisted.

## Stowing the center safety belt

If the center seat is not occupied, insert the belt buckles 3 and 4 into the respective holders, arrows.

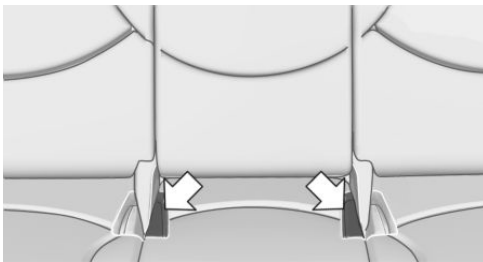

Move the buckle tongues to the belt holder on the headliner, refer to page 38, and insert them into the provided holders.

## Safety belt reminder for driver's seat and front passenger seat



The indicator lamps light up and a signal sounds. Check whether the safety belt has been fastened correctly.



## Damage to safety belts

In the case of strain caused by accidents or damage:

Have the safety belts, including the safety belt tensioners, replaced and have the belt anchors checked.



Checking and replacing safety belts

Have the work performed only by your service center; otherwise, it cannot be ensured that this safety feature will function properly. ◀

## HEAD RESTRAINTS

### Correctly set head restraint

A correctly adjusted head restraint reduces the risk of spinal injury in the event of an accident.



Adjusting the head restraint

Correctly adjust the head restraints of all occupied seats; otherwise, there is an increased risk of injury in an accident. ◀

### Height

Adjust the head restraint so that its center is approx. at ear level.

MINI Countryman: the center rear head restraint is not height adjustable.

## Height adjustment

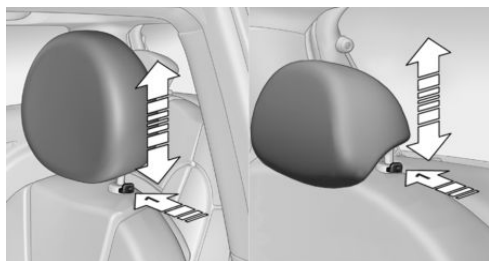

To raise: pull.

To lower: press the button, arrow 1, and push the head restraint down until it engages.

MINI Countryman: additionally press button 2 on the rear head restraints only if you wish to remove them.

## Removing

Only remove the head restraint if no one will be sitting in the seat in question.

 Before transporting passengers  
Reinstall the head restraint before transporting anyone in the seat; otherwise, the protective function of the head restraint is unavailable. ◀

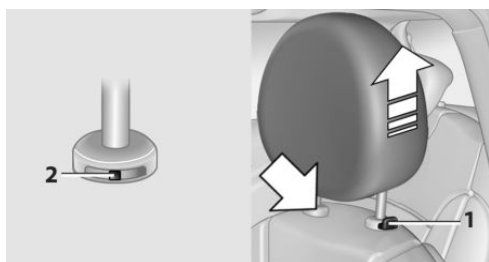

## Front

1. Pull the head restraint upward as far as possible.
2. MINI Countryman: tilt the backrest back slightly.

MINI Paceman: fold the backrest forward if necessary.

3. Press button 1 and pull out the head restraint all the way to the stop.

MINI Countryman: additionally press button 2 using a suitable tool.

4. Pull out the head restraint.
5. Fold back the backrest.

## Rear

1. Pull the head restraint upward as far as possible.
2. Fold the backrest forward slightly.
3. Press button 1 and pull out the head restraint all the way to the stop.

MINI Countryman: additionally press button 2 using a suitable tool.

4. Pull out the head restraint completely.
5. Fold back the rear seat backrest.

## MIRRORS

### Exterior mirrors

#### General information

The mirror on the passenger side is more curved than the driver's mirror.

 Estimating distances correctly  
Objects reflected in the mirror are closer than they appear. Do not estimate the distance to the traffic behind you based on what you see in the mirror, as this will increase your risk of an accident. ◀

## At a glance

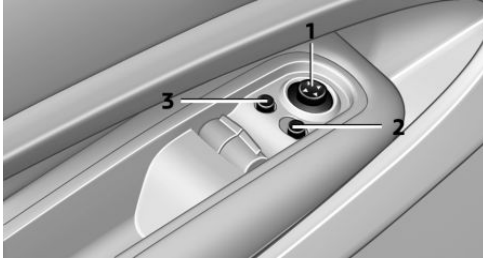

- 1 Adjusting
- 2 Selecting the left/right mirror
- 3 Folding the mirror in and out

## Selecting a mirror



To change to the other mirror: slide the mirror switch over.

## Adjusting electrically



The setting corresponds to the direction in which the button is pressed.

## Adjusting manually

If an electrical malfunction occurs, for example, press the edges of the mirror glass.

## Folding the mirror in and out

Press button 3.

The mirror can be folded in up to a vehicle speed of approx. 20 mph/30 km/h.

For example, this is advantageous

- ▷ In car washes.
- ▷ In narrow streets.
- ▷ For folding back mirrors that were folded away manually.



Fold in the mirror in a car wash

Before entering an automatic car wash, fold in the exterior mirrors by hand or with the button; otherwise, they could be damaged, depending on the width of the vehicle. ◀

## Automatic heating

Both exterior mirrors are heated automatically while the engine is running or the ignition is switched on when the external temperature is below a certain value.

## Interior rearview mirror

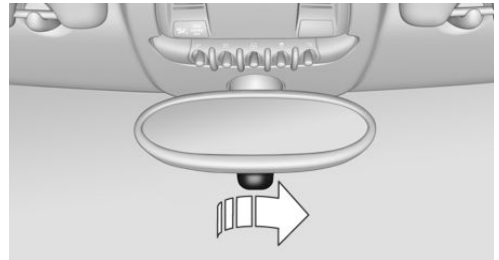

To reduce the blinding effect from the rear when driving at night: turn the knob.

## Interior rearview and exterior mirrors, automatic dimming feature

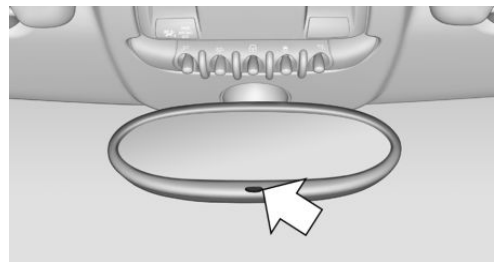

Two photocells are used for control:

- ▷ In the mirror frame, see arrow.
- ▷ On the back of the mirror.

For proper operation:

- ▷ Keep the photocells clean.

- ▷ Do not cover the area between the inside rearview mirror and the windshield.
- ▷ Do not apply stickers to the windshield in front of the mirror.

## STEERING WHEEL

### Adjusting



Do not adjust while driving

Do not adjust the steering wheel while driving; otherwise, an unexpected movement could result in an accident. ◀

1. Fold the lever down.

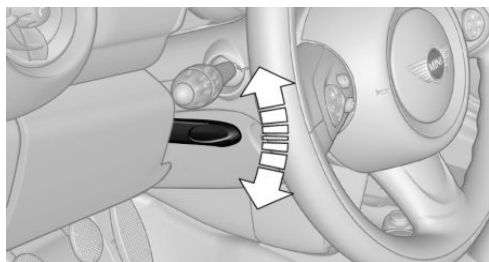

2. Move the steering wheel to the preferred height and angle to suit your seating position.
3. Fold the lever back.



Do not use force to swing the lever back.

Do not use force to swing the lever back up; otherwise, the mechanism will be damaged. ◀

# TRANSPORTING CHILDREN SAFELY

## VEHICLE EQUIPMENT

This chapter describes all series equipment as well as country-specific and special equipment offered for this model series. Therefore, it also describes equipment that may not be found in your vehicle, for instance due to the selected special equipment or the country version. This also applies to safety-related functions and systems.

When using the features and systems described here, adhere to local regulations.

## THE RIGHT PLACE FOR CHILDREN

### Notes

 Children in the vehicle  
Do not leave children unattended in the vehicle; otherwise, they could endanger themselves and other persons, e.g., by opening the doors. ◀

### Children should always be in the rear

Accident research shows that the safest place for children is on the rear seat.

 Transporting children in the rear  
Transport children younger than 13 years of age or shorter than 5 ft/150 cm in the rear only, using child restraint fixing systems suitable for the age, weight, and height of the child; otherwise, there is an increased risk of injury in an accident.

Children 13 years of age or older must wear a safety belt as soon as a suitable child restraint fixing system can no longer be used, due to their age, weight and size. ◀

 Installing child seats  
Only install child seats in the rear when the rear seat backrest is folded all the way back and engaged; otherwise, there is an increased risk of injury in an accident. ◀

### Children on the front passenger seat

#### Front passenger airbags

Should it be necessary to use a child restraint fixing system on the front passenger seat, make sure that the front and side airbags on the front passenger side are deactivated, refer to page 72.

 Deactivating the front passenger airbags  
If a child restraint fixing system is used in the front passenger seat, the front passenger airbags must be deactivated; otherwise, there is an increased risk of injury to the child when the airbags are triggered, even with a child restraint fixing system. ◀

## INSTALLING CHILD RESTRAINT FIXING SYSTEMS

### Before mounting

MINI Countryman: before mounting a child restraint fixing system on the rear seats, move the seats into the rearmost positions.

Adjust the inclination of the center backrest to that of the respective outer backrest.

After mounting the child restraint fixing system on the respective outer rear seat, adjust the backrest forward, if necessary, to ensure that the backrest is in contact with the child restraint fixing system. Rear seat backrests, refer to page 100.

## Notes

**!** Manufacturer's information for child restraint fixing systems

To select, mount and use child restraint fixing systems, observe the information provided by the system manufacturer; otherwise, the protective effect can be impaired. ◀

## On the front passenger seat

### Deactivating the airbags

After installing a child restraint fixing system on the front passenger seat, ensure that the front, side, and knee airbags on the front passenger side are deactivated.

**!** Deactivating the front passenger airbags

If a child restraint fixing system is used in the front passenger seat, the front passenger airbags must be deactivated; otherwise, there is an increased risk of injury to the child when the airbags are triggered, even with a child restraint fixing system. ◀

### Seat position and height

Before installing a child restraint fixing system, move the front passenger seat as far back as possible and adjust its height to the highest position to obtain the best possible position for the belt and to offer optimal protection in the event of an accident.

Do not change this seat position once it has been set.

## Child seat security

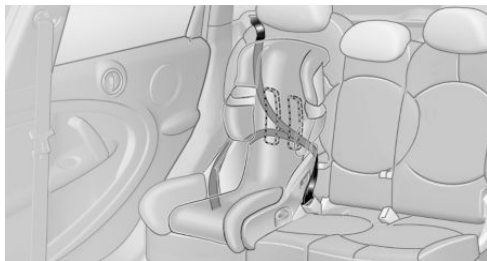

The graphic shows the MINI Countryman as an example.

The rear safety belts and the safety belt for the front passenger can be locked to prevent extension in order to permit attachment of child restraint fixing systems.

### To lock the safety belt

1. Secure the child restraint fixing system with the belt.
2. Pull out the belt webbing completely.
3. Allow the belt webbing to be pulled in and pull it taut against the child restraint fixing system.

The safety belt is locked.

### To unlock the safety belt

1. Open the belt buckle.
2. Remove the child restraint fixing system.
3. Allow the belt webbing to be pulled in completely.

Center safety belt: unlock belt buckle 3 in addition, refer to page 39.

Guide the safety belt to the holder on the headliner.

## LATCH CHILD RESTRAINT FIXING SYSTEM

LATCH: Lower Anchors and Tethers for Children.

## Notes

 Manufacturer's information for LATCH child restraint fixing systems

To mount and use the LATCH child restraint fixing systems, observe the operating and safety information from the system manufacturer; otherwise, the level of protection may be reduced. ◀

## Mounts for the lower LATCH anchors

The lower anchors may be used to attach the CRS to the vehicle seat up to a combined child and CRS weight of 65 lb/30 kg when the child is restrained by the internal harnesses.

 Correctly engage the lower LATCH anchors

Make sure that the lower LATCH anchors have properly engaged and that the child restraint fixing system is resting snugly against the backrest; otherwise, the degree of protection offered may be reduced. ◀

Before installing the child seat, pull the belt out of the area for the child restraint fixing system.

## MINI Countryman

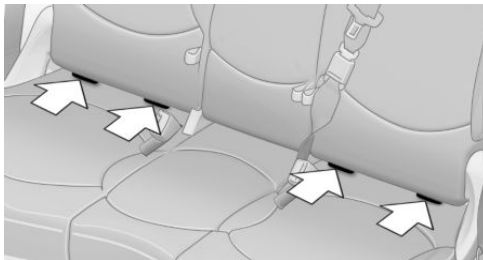

The mounts for the lower LATCH anchors are located at the points indicated by the arrows.

## MINI Paceman

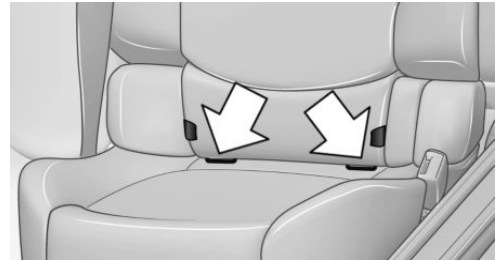

The mounts for the lower LATCH anchors are located at the points indicated by the arrows.



The corresponding symbol shows the mounts for the lower LATCH anchors.



## Mounting LATCH child restraint fixing systems

1. Mount the child restraint fixing system; refer to the operating instructions of the system.
2. Ensure that both LATCH anchors are properly connected.

## CHILD RESTRAINT FIXING SYSTEMS WITH AN UPPER RETAINING STRAP

### Mounting points



LATCH mounting points

Only use the mounting points for the upper LATCH retaining strap to secure child restraint systems; otherwise, the mounting points could be damaged. ◀

### MINI Countryman



There are two additional mounting points for child restraint fixing systems with an upper retaining strap, arrows.

### MINI Paceman

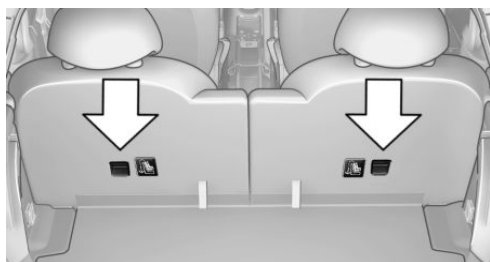

There are two additional mounting points for child restraint fixing systems with an upper retaining strap, arrows.

### Guide of the upper LATCH retaining strap

 Retaining strap

Make sure the upper retaining strap does not run over sharp edges and is not twisted as it passes to the top anchor. Otherwise, the strap will not properly secure the child restraint fixing system in the event of an accident. ◀

### Outer seats:

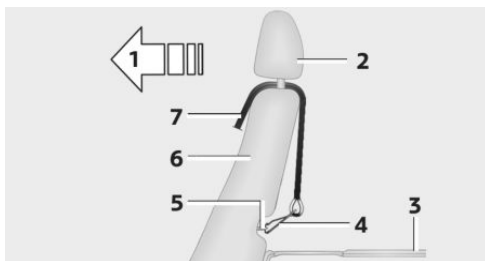

- 1 Direction of travel
- 2 Head restraint
- 3 Cargo area floor
- 4 Hook for upper retaining strap
- 5 Mounting point
- 6 Backrest
- 7 Upper retaining strap of child restraint fixing system

### MINI Countryman, center seat

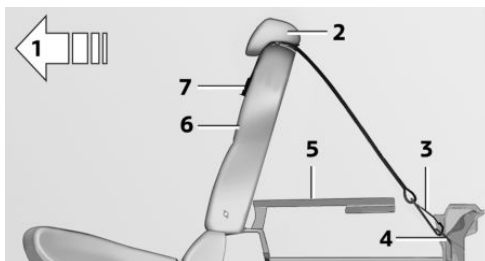

- 1 Direction of travel
- 2 Head restraint
- 3 Hook for upper retaining strap
- 4 Mounting point
- 5 Cargo area floor
- 6 Backrest
- 7 Upper retaining strap of child restraint fixing system



### Attaching the upper retaining strap to the mounting point

1. Slide the head restraint upward.
2. Center seat: fold the cargo area floor forward.
3. Guide the upper retaining strap between the supports of the head restraint.
4. Attach the upper retaining strap to the mounting point with the hook.
5. Slide the head restraint into the bottom position.
6. Pull the upper retaining strap taut.

## MINI COUNTRYMAN: LOCKING DOORS AND WINDOWS

### Rear doors

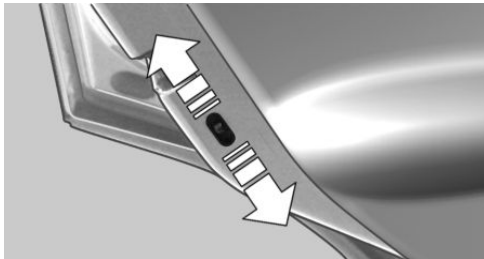

Push the locking lever on the rear doors down. The door can now be opened from the outside only.

### Safety switch for power window

This locks the rear window switches so that the windows cannot be operated from the rear. Press the safety switch, refer to page [34](#).

# DRIVING

## VEHICLE EQUIPMENT

This chapter describes all series equipment as well as country-specific and special equipment offered for this model series. Therefore, it also describes equipment that may not be found in your vehicle, for instance due to the selected special equipment or the country version. This also applies to safety-related functions and systems.

When using the features and systems described here, adhere to local regulations.

## IGNITION LOCK

### Insert the remote control into the ignition lock

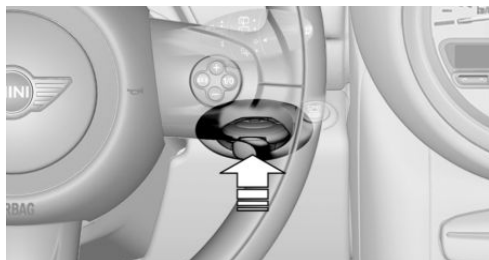

Insert the remote control all the way into the ignition lock.

Radio ready state is switched on. Individual electrical consumers can operate.

### Removing the remote control from the ignition lock

 Do not forcibly pull the remote control out of the ignition lock

Do not forcibly pull the remote control out of the ignition lock as this may cause damage. ◀

Before removing the remote control, push it all the way in to release the locking mechanism.

The ignition is switched off if it was on.

### Steptronic transmission

You can only take out the remote control if transmission position P is engaged: interlock.

## START/STOP BUTTON

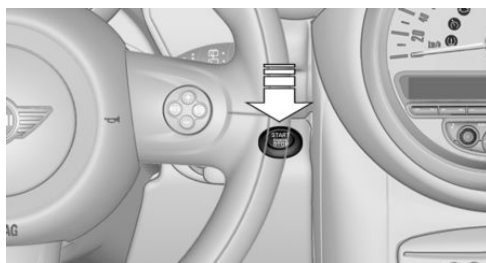

Pressing the Start/Stop button switches the ignition on or off and starts the engine.

The engine starts when the Start/Stop button is pressed and:

- ▷ Manual transmission: the clutch pedal is depressed.
- ▷ Steptronic transmission: the brake pedal is depressed.

### Radio ready state

Individual electrical consumers can operate.

Radio ready state is switched off automatically:

- ▷ When the remote control is removed from the ignition lock.
- ▷ With Comfort Access, refer to page 28, by pressing the button on the door handle or the  button on the remote control.
- ▷ After a certain period of time.

## Ignition on

All electrical consumers can operate. Most indicator and warning lights light up for different lengths of time.

To save battery power when the engine is off, switch off the ignition and any unnecessary electronic systems/power consumers.

## Radio ready state and ignition off

All indicator and warning lights in the displays go out.

The ignition switches off automatically when the driver's door is opened. Pressing the Start/Stop button again switches the ignition back on.

For example, the ignition is not switched off in the following situations:

- ▷ Depress the clutch or brake pedal.
- ▷ The low beams are switched on.

## STARTING THE ENGINE

### General information

 **Enclosed areas**  
Do not let the engine run in enclosed areas; otherwise, breathing of exhaust fumes may lead to loss of consciousness and death. The exhaust gases contain carbon monoxide, an odorless and colorless but highly toxic gas. ◀

 **Unattended vehicle**  
Do not leave the car unattended with the engine running; otherwise, it presents a potential source of danger.

Before leaving the car with the engine running, shift to neutral or engage transmission position P and set the parking brake firmly; otherwise, the vehicle may begin to roll. ◀

 **Frequent starting in quick succession**  
Avoid repeated futile attempts at starting the car and avoid starting the car frequently in quick succession. Otherwise, the fuel is not burned or is inadequately burned, and there is the danger of overheating and damaging the catalytic converter. ◀

Do not wait for the engine to warm-up while the vehicle remains stationary; start driving right away, but at moderate engine speeds.

Do not depress the accelerator when starting the engine.

### Starting the engine

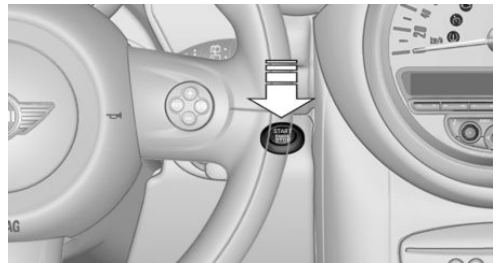

### Manual transmission

Remote control in the ignition lock or with Comfort Access inside the vehicle, refer to page 28.

1. Depress the brake pedal.
2. Depress the clutch pedal.
3. Press the Start/Stop button.

The ignition is activated automatically for a certain time and is stopped as soon as the engine starts.

### Steptronic transmission

Remote control in the ignition lock or, with Comfort Access, inside the vehicle, refer to page 28.

1. Depress the brake pedal.
2. Move the selector lever to position P or N.

### 3. Press the Start/Stop button.

The ignition is activated automatically for a certain time and is stopped as soon as the engine starts.

## ENGINE STOP

### General information

 Take the remote control with you  
Take the remote control with you when leaving the vehicle so that children, for example, cannot operate the windows and injure themselves. ◀

 Set the parking brake and further secure the vehicle as required

Set the parking brake firmly when parking; otherwise, the vehicle may roll. On steep upward and downward inclines, further secure the vehicle, for example, by turning the steering wheel in the direction of the curb. ◀

### Before driving into a car wash

To make it possible for the vehicle to roll in an automatic car wash, follow the information on Washing in automatic car washes, refer to page 186.

### Switching off the engine

#### Manual transmission

1. With the vehicle at a standstill, press the Start/Stop button.
2. Shift into first gear or reverse.
3. Set the parking brake firmly.
4. Remove the remote control from the ignition lock.

#### Steptronic transmission

1. Engage transmission position P with the vehicle stopped.
2. Press the Start/Stop button.
3. Set the parking brake firmly.
4. Remove the remote control from the ignition lock.

## PARKING BRAKE

### The concept

The parking brake is primarily intended to prevent the vehicle from rolling while parked; it brakes the rear wheels.

Also follow the instructions under Switching off the engine, refer to page 50.

### Setting

The lever engages automatically.

### Releasing

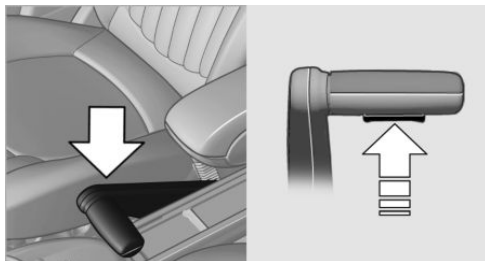

Pull up slightly, press the button, and lower the lever.

### Notes

 Using the parking brake while driving  
If it should become necessary to use the parking brake while driving, do not pull the parking brake too forcefully. Keep the button on the parking brake lever pressed at all times.

Excessive application of the parking brake can block the rear wheels and lead to fishtailing of the vehicle. ◀

The brake lights do not light up when the parking brake is pulled.

## TURN SIGNAL, HIGH-BEAMS, HEADLIGHT FLASHER

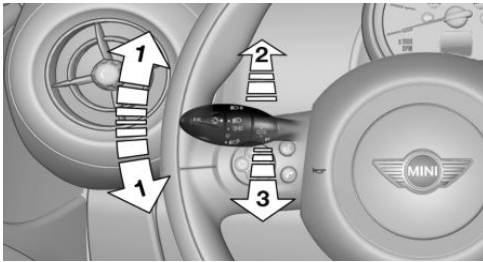

- 1 Turn signal
- 2 Switching on the high-beams
- 3 Switching off the high-beams/headlight flasher

### Turn signal

Press the lever beyond the resistance point.

To switch off manually, press the lever to the resistance point.

Unusually rapid flashing of the indicator lamp indicates that a turn signal bulb has failed.

### Signaling a turn briefly

Press the lever to the resistance point and hold it there for as long as you want the turn signal to flash.

### Triple turn signal activation

Press the lever to the resistance point.

The turn signal flashes three times.

This function can be activated or deactivated:

1. Switch on the ignition, refer to page 49.
2. Press the button on the turn indicator lever repeatedly until "SET/INFO" is displayed.

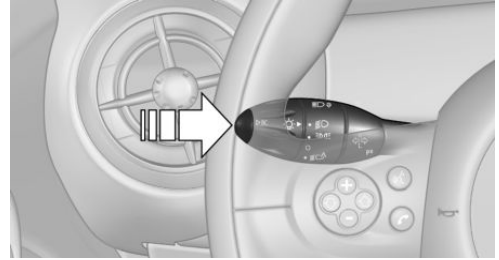

3. Press and hold the button until the display changes.
4. Press the button repeatedly until the symbol and "SET" are displayed.

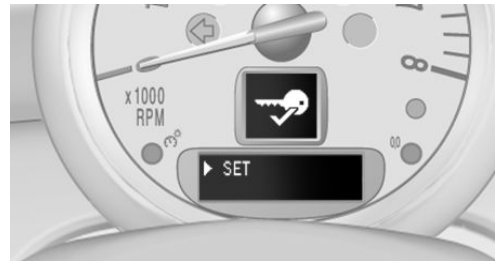

5. Press and hold the button until the display changes.
6. Press the button repeatedly until the symbol shown is displayed, arrow.

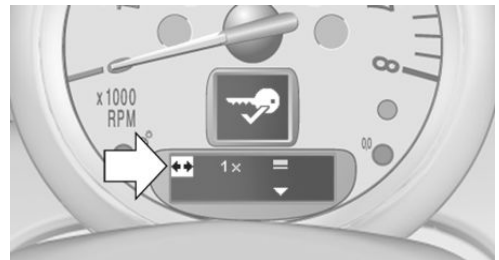

7. Press and hold the button until the display changes.
8. Press the button to select:

- ▷ **1 x**  
Turn signal flashes once.
  - ▷ **3 x**  
Triple turn signal.
9. Press and hold the button until the display changes.

The setting is stored for the remote control currently in use.

## WASHER/WIPER SYSTEM

### Notes

 Do not switch on the wipers if frozen  
Do not switch on the wipers if they are frozen onto the windshield; otherwise, the wiper blades and the windshield wiper motor may be damaged. ◀

 Do not use the wipers on a dry windshield  
Do not use the wipers on a dry windshield; otherwise, the wiper blades may wear more rapidly or become damaged. ◀

### At a glance

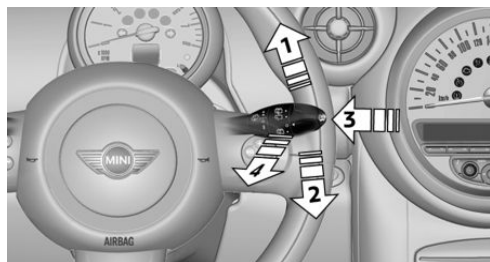

- 1 Switching on wipers
- 2 Switching off wipers or brief wipe
- 3 Activating/deactivating intermittent wipe or the rain sensor
- 4 Cleaning the windshield and headlights

### Switching on wipers

Press the wiper lever upward, arrow 1.

The lever automatically returns to its initial position when released.

### Normal wiper speed

Press up once.

The system switches to operation in the intermittent mode when the vehicle is stationary.

### Fast wiper speed

Press up twice or press once beyond the resistance point.

The system switches to normal speed when the vehicle is stationary.

### Switching off wipers or brief wipe

Press the wiper lever down, arrow 2.

The lever automatically returns to its initial position when released.

- ▷ Brief wipe: press down once.
- ▷ To switch off normal wipe: press down once.
- ▷ To switch off fast wipe: press down twice.

### Intermittent wipe or rain sensor

If the car is not equipped with a rain sensor, the intermittent-wipe time is a preset.

If the car is equipped with a rain sensor, the time between wipes is controlled automatically and depends on the intensity of the rainfall.

The rain sensor is mounted on the windshield, directly in front of the interior rearview mirror.

 Deactivate the rain sensor in car washes  
Deactivate the rain sensor when passing through an automatic car wash; otherwise, damage could be caused by undesired wiper activation. ◀

### Activating intermittent wipe or rain sensor

Press the button, arrow 3.



The symbol is shown in the tachometer.

### Setting the sensitivity of the rain sensor

1. Switch on the ignition, refer to page 49.
2. Press the button on the turn indicator lever repeatedly until "SET/INFO" is displayed.

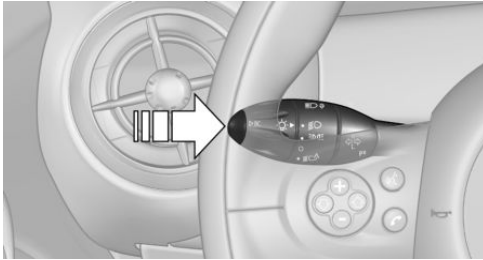

3. Press and hold the button until the display changes.
4. Press the button repeatedly until the symbol and "SET" are displayed.

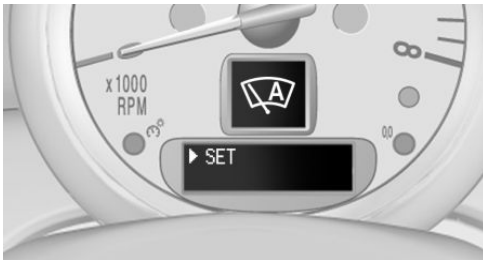

5. Press and hold the button until the display changes.



6. Press the button to select the desired sensitivity.
7. Wait or hold the button until the display changes.

The settings were stored.

### Deactivating intermittent wipe or rain sensor

Press the button again, arrow 3.

### Cleaning the windshield and headlights

Pull the lever, arrow 4.

The system sprays washer fluid on the windshield and activates the wipers briefly.

When the vehicle lighting system is switched on, the headlights are cleaned at regular and appropriate intervals.



Do not use the washer system at freezing temperatures

Do not use the washers if there is any danger that the fluid will freeze on the windshield; otherwise, your vision could be obscured. For this reason, use antifreeze.

Avoid using the washer when the reservoir is empty; otherwise, you could damage the pump. ◀

**!** Do not use the washing facilities when the hood is open

Only use the washing facilities when the hood is fully locked; otherwise, the headlamp washer system may become damaged. ◀

### Windshield washer nozzles

The windshield washer nozzles are heated automatically while the engine is running or the ignition is switched on.

### Rear window wiper

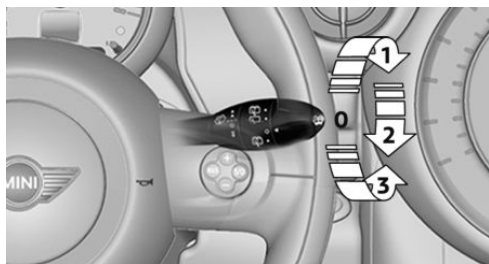

- 0** Resting position
- 1** Switching on intermittent wipe  
Turn the cap to level 1.  
When reverse gear is engaged, the system switches to continuous operation.
- 2** Cleaning the rear window with intermittent wipe  
Turn the cap further to level 2 and hold.
- 3** Cleaning the rear window in the resting position  
Turn the cap to level 3 and hold.

The rear window wiper does not move if the cap is in position 1 before the ignition is switched on.

To switch on the rear window wiper:

1. Move the cap to its basic position.
2. Select the required position again.

**!** Do not use the washing mechanisms when the washer fluid reservoir is empty

Do not use washing mechanisms when the washer fluid reservoir is empty, otherwise you will damage the washer pump. ◀

## WASHER FLUID

### General information

**!** Antifreeze for washer fluid  
Antifreeze is flammable and can cause injuries if used improperly.

Therefore, keep it away from sources of ignition.

Only keep it in the closed original container and inaccessible to children.

Follow the notes and instructions on the container.

United States: The washer fluid mixture ratio is regulated by the U.S. EPA and many individual states; do not exceed the allowable washer fluid dilution ratios limits that apply. Follow the usage instructions on the washer fluid container. Use BMW's Windshield Washer Concentrate or the equivalent. ◀

### Washer fluid reservoir

**!** Adding washer fluid  
Only add washer fluid when the engine is cool, and then close the cover completely to avoid contact between the washer fluid and hot engine parts.

Otherwise, there is the danger of fire and a risk to personal safety if the fluid is spilled. ◀



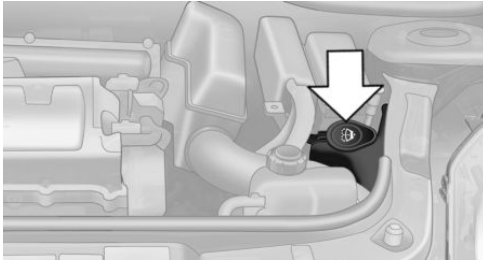

All washer nozzles are supplied from one reservoir.

The recommended minimum filling quantity is 0.2 US gal/1 liter.

Fill with a mixture of window washing concentrate and water; if needed, add antifreeze according to the manufacturer instructions.

Mix the washer fluid before adding to maintain the correct mixing ratio.

Do not fill in undiluted window washing concentrate and do not fill in pure water; this could damage the washer system.

Do not mix window washing concentrate from different manufacturers; this could cause the washer nozzles to clog.

## MANUAL TRANSMISSION

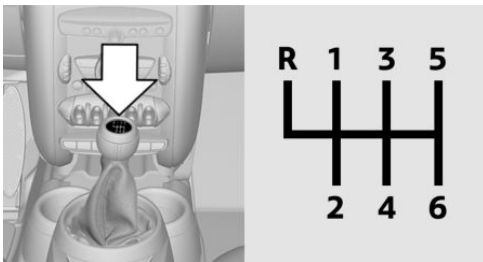

**!** Pay attention to the shift plane

When shifting into 5th or 6th gear, push the gearshift lever to the right; otherwise inadvertent shifting into the 3rd or 4th gear could lead to engine damage. ◀

## Reverse gear

Select only when the vehicle is stationary. When the gearshift lever is pressed to the left, a slight resistance needs to be overcome.

## STEPTRONIC TRANSMISSION

In addition to the fully automatic mode, gears can also be shifted manually using Steptronic, refer to page 56.

## Parking the vehicle

**!** Secure the vehicle

Before leaving the vehicle with the engine running, move the selector lever to position P and set the handbrake; otherwise, the vehicle will begin moving. ◀

## Disengaging the remote control

To remove the remote control from the ignition lock, first move the selector lever to position P and switch off the engine: interlock. Remove the remote control from the ignition lock, refer to page 48.

## Selector lever positions

P R N D M/S + -

## Displays in the tachometer

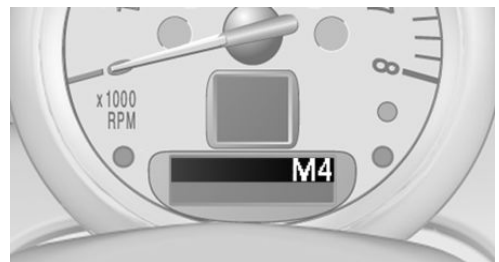

The selector lever position is displayed and the engaged gear, such as M4, is displayed in manual mode.

## Changing selector lever positions

- ▷ With the ignition switched on or the engine running, the selector lever can be moved out of position P.
- ▷ When the vehicle is stationary, step on the brake before shifting out of P or N; otherwise, the selector lever is locked: shiftlock.

 Press on the brake pedal until you start driving

To prevent the vehicle from creeping after you select a driving position, maintain pressure on the brake pedal until you are ready to start. ◀



A lock prevents accidental shifting into selector lever positions R and P.

To override the lock, press the button on the front of the selector lever, see arrow.

## P Park

Select only when the vehicle is stationary. The front wheels are blocked.

## R is Reverse

Select only when the vehicle is stationary.

## N is Neutral

For example, engage this position in a car wash. The vehicle can roll.

## D Drive

Position for normal vehicle operation. All forward gears are selected automatically.

Under normal operating conditions, fuel consumption is lowest when you are driving in position D.

## Kickdown

Kickdown is used to achieve maximum driving performance. Press on the accelerator beyond the resistance point at the full throttle position.

## Sport program and manual mode M/S

### Activating the Sport program



Move the selector lever from position D toward the left into the M/S shifting slot.

The Sport program is activated and DS is displayed. This position is recommended for a performance-oriented driving style.

To deactivate the Sport program or manual mode M/S, move the selector lever to the right into position D.

### Activating the M/S manual mode

Move the selector lever from position D toward the left into the M/S shifting slot.

Push the selector lever forward or backward.

Manual mode becomes active and the gear is changed.

The tachometer displays the engaged gear, e. g. M1.

- ▷ To shift up: press the selector lever backward.
- ▷ To shift down: press the selector lever forward.

The vehicle only shifts up or down at appropriate engine and road speeds, e.g., it does not shift down if the engine speed is too high. The selected gear is briefly displayed in the instrument panel, followed by the current gear.

### Shifting gears using the shift paddles on the steering wheel

The shift paddles on the steering wheel allow you to shift gears quickly while keeping both hands on the steering wheel.

- ▷ When the shift paddles on the steering wheel are used to shift gears while in automatic mode, the transmission switches to manual mode.
- ▷ If the shift paddles are not used to accelerate or shift gears for a certain amount of time, the transmission switches back to automatic mode.

If the selector lever is in the M/S gear plane, manual mode remains active.

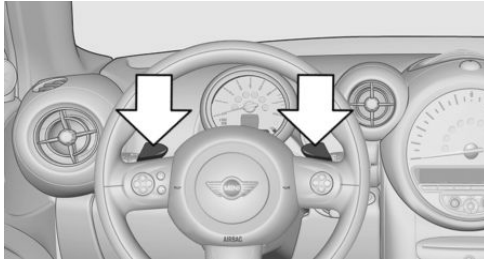

- ▷ Pull one of the two shift paddles:  
The transmission shifts up.
- ▷ Press one of the two shift paddles:  
The transmission shifts down.

The vehicle only shifts up or down at appropriate engine and road speeds, e.g., it does not shift down if the engine speed is too high. The selected gear is briefly displayed in the instrument panel, followed by the current gear.

### Manually unlocking the selector lever lock

If the selector lever is locked in position P although the ignition is switched on, the brake is depressed, and the button on the selector lever is pressed, the selector lever lock can be overridden:

1. Switch off the ignition.
2. Unclip the sleeve of the selector lever.
3. Pull the sleeve up over the selector lever until the sleeve is inside out.  
Pull off the plug-in cable connector if necessary.

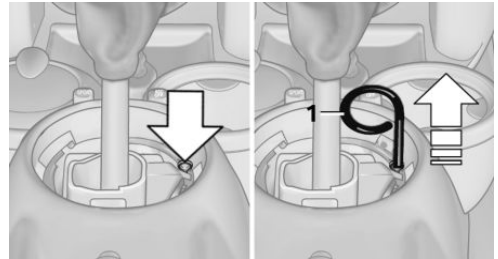

4. Insert the pulling hook 1 into the loop on the passenger side.  
The pulling hook is found in the vehicle document portfolio or in the pouch of the wheel change set, refer to page 178.
5. Pull the loop upward.
6. Move the selector lever into the desired position, pressing the button on the front of the selector lever.



Set the parking brake

Manually unlock the selector lever lock for towing only. Before manually unlocking the selector lever lock, pull the parking brake firmly; otherwise, the vehicle may roll away and cause personal injury or property damage. ◀

# DISPLAYS

## VEHICLE EQUIPMENT

This chapter describes all series equipment as well as country-specific and special equipment offered for this model series. Therefore, it also describes equipment that may not be found in your vehicle, for instance due to the selected special equipment or the country version. This also applies to safety-related functions and systems.

When using the features and systems described here, adhere to local regulations.

## ODOMETER, EXTERNAL TEMPERATURE DISPLAY, CLOCK

### At a glance

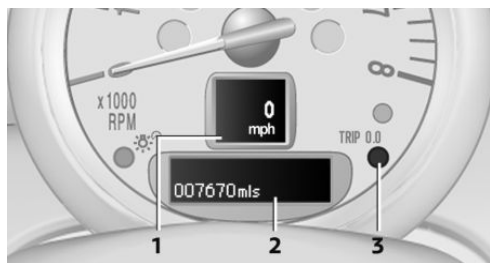

- 1 Current speed
- 2 Odometer, trip odometer, external temperature, time
- 3 Resetting the trip odometer

Press the button on the turn indicator lever to open information in display area 2.

The following information is displayed consecutively:

- ▷ Trip odometer
- ▷ Time
- ▷ External temperature

### Trip odometer

#### Displaying the trip odometer

Press button 3 briefly.

#### Resetting the trip odometer

1. Press button 3 briefly.  
The trip odometer is displayed.
2. Press button 3 again.  
The trip odometer is reset.

### Time

Set the time, refer to page 62.

### External temperature, external temperature warning

If the display drops to  $+37^{\circ}\text{F}/+3^{\circ}\text{C}$ , a signal sounds and a warning light lights up. There is the increased danger of ice.



#### Ice on roads

Even at temperatures above  $+37^{\circ}\text{F}/+3^{\circ}\text{C}$ , there can be a risk of ice on roads.

Therefore, drive carefully on bridges and shady roads, for example, to avoid the increased danger of an accident. ◀

### Units of measure

To set the respective units of measure, miles or km for the odometer and  $^{\circ}\text{C}$  or  $^{\circ}\text{F}$  for the external temperature, refer to page 61.

## TACHOMETER



It is imperative that you avoid engine speeds in the red warning field. In this range, the fuel supply is interrupted to protect the engine.

## COOLANT TEMPERATURE

A warning lamp will come on if the coolant, and therefore the engine, becomes too hot.

Check the coolant level, refer to page 168.

## FUEL GAUGE

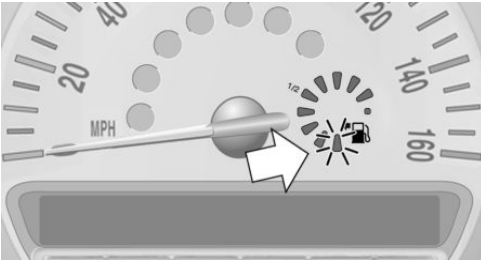

The arrow next to the fuel pump symbol on the fuel gauge indicates the side of the vehicle with the fuel filler flap.

The vehicle inclination may cause the display to vary.

Notes on refueling, refer to page 148.

Filling capacities, refer to page 209.

### Range

After the reserve range is reached:

- ▷ The remaining LEDs change from orange to red, arrow.
- ▷ The remaining range is shown on the tachometer.
- ▷ When a dynamic driving style is used, such as when corners are taken rapidly, engine functions are not ensured.

A warning light lights up below a range of approx. 30 miles/50 km.



Refuel promptly

At the latest, refuel at a range below 30 miles/50 km; otherwise, the engine function is not ensured and damage may occur. ◀

## COMPUTER

### Opening information in the tachometer

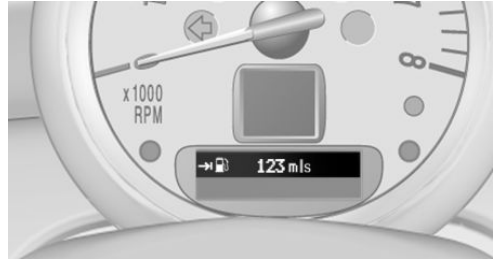

Press the button on the turn indicator lever.

### Overview of the information

The following information is displayed consecutively by repeatedly pressing the button on the turn indicator lever:

- ▷ Range.
- ▷ Average fuel consumption.
- ▷ Current fuel consumption.
- ▷ Average speed.

To set the corresponding units of measure, refer to page 61.

## Information in detail

### Range

Displays the estimated cruising range available with the remaining fuel.

It is calculated based on your driving style over the last 18 miles/30 km.

### Average fuel consumption

This is calculated for the period during which the engine is running.

To reset the average consumption: press the button on the turn indicator lever for approx. 2 seconds.

### Current fuel consumption

Displays the current fuel consumption. You can check whether you are currently driving in an efficient and environmentally-friendly manner.

### Average speed

Periods in which the vehicle was parked and the engine was switched off manually are not included in the average speed calculations.

To reset the average speed: press the button on the turn indicator lever for approx. 2 seconds.

### Radio MINI Boost CD: displays on the radio

Some computer functions can also be shown on the radio display, refer to page 125.







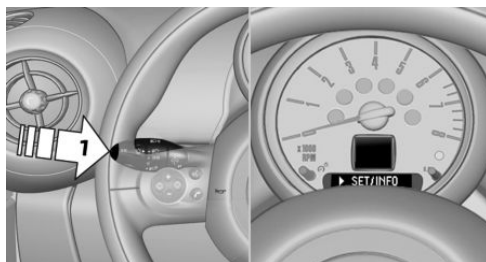



## SETTINGS AND INFORMATION





### Operating concept

Some settings and information can only be created or opened while the ignition is switched on, the vehicle is standing, and the doors are closed.



- 1** Button for:
- ▷ Selecting the display.
  - ▷ Setting values.
  - ▷ Confirming the selected display or set values.
  - ▷ Calling up computer information [59](#).

Symbol	Function
	Set the rain sensor, refer to page <a href="#">52</a> .
	
	Open Check-Control, refer to page <a href="#">64</a> .
	
	View service requirement display, refer to page <a href="#">63</a> .
	
	Initialize the Flat Tire Monitor, refer to page <a href="#">74</a> .
	Resetting the Tire Pressure Monitor, refer to page <a href="#">77</a> .
	Set the formats and units of measure, reset to the factory settings, refer to page <a href="#">61</a> .
	

Symbol	Function
	Personal Profile settings, refer to page 20.
	
	Exit the menu.
	

### Exiting displays

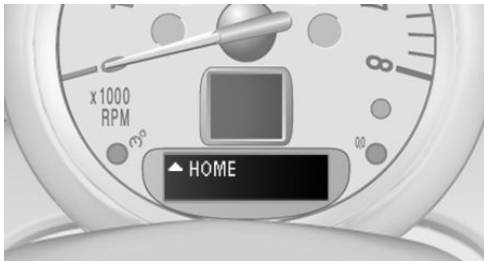

1. Press the button on the turn indicator lever repeatedly until "HOME" is displayed.
2. Hold the button down.

The current speed is displayed again.

Displays are also exited if no entries are made within approx. 8 seconds.

### Next setting or information

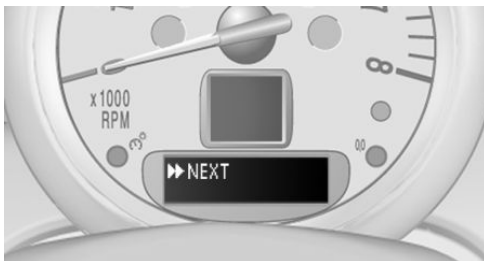

1. Within a setting or information display, press the button on the turn indicator lever repeatedly until "NEXT" is displayed.

2. Hold the button down.

Direct change to the next setting or piece of information.

## FORMATS AND UNITS OF MEASURE

The formats and units of measure can be set. The settings are stored for the remote control in use.

1. Switch on the ignition, refer to page 48.
2. Press the button on the turn indicator lever repeatedly until "SET/INFO" is displayed.

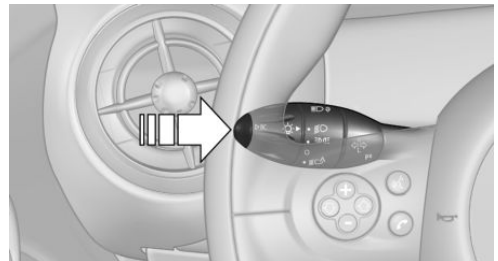

3. Press and hold the button until the display changes.
4. Press the button repeatedly until the symbol and "SET" are displayed.

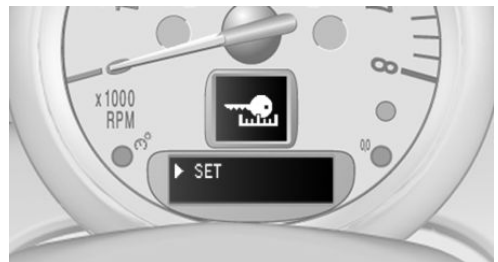

5. Press and hold the button until the display changes.
6. Press the button repeatedly until the symbol shown is displayed, arrow.

▶  Fuel consumption: l/100 km, mpg, km/l

- ▷ Distance: km, mi.
- ▷ Temperature: °C, °F

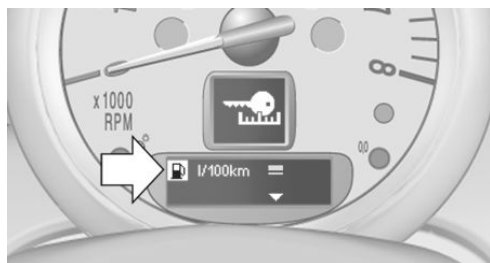

7. Press and hold the button until the display changes.
8. Press the button to change the format or the unit of measure.
9. Press and hold the button until the display changes.  
The settings are stored.

### Resetting to factory settings

The settings for formats and units of measure can be reset to the factory settings. The settings are stored for the remote control in use.

1. Press the button on the turn indicator lever repeatedly until "SET/INFO" is displayed.

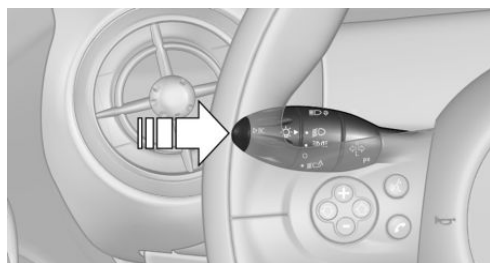

2. Press and hold the button until the display changes.

3. Press the button repeatedly until the symbol and "SET" are displayed.

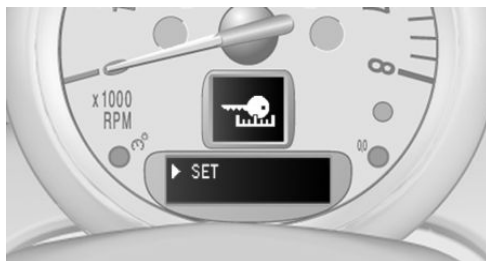

4. Press and hold the button until the display changes.
5. Press the button repeatedly until "RESET" appears on the display.

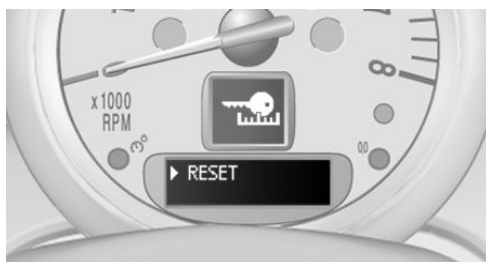

6. Press and hold the button until the display changes to the first setting option.  
The settings are reset.

## CLOCK

### Setting the time

Radio MINI Boost CD: set the time, refer to page 124.

## DATE

### Setting the date

Radio MINI Boost CD: set the date, refer to page 124.



## SERVICE REQUIREMENTS



The remaining driving distance and the date of the next scheduled service are displayed briefly immediately after you start the engine or switch on the ignition.

The current service requirements can be read out from the remote control by the service specialist.

### Displaying the vehicle check

For certain maintenance operations, you can view the distance remaining or the due date for that operation in the tachometer.

1. Switch on the ignition, refer to page 48.
2. Press the button on the turn indicator lever repeatedly until "SET/INFO" is displayed.

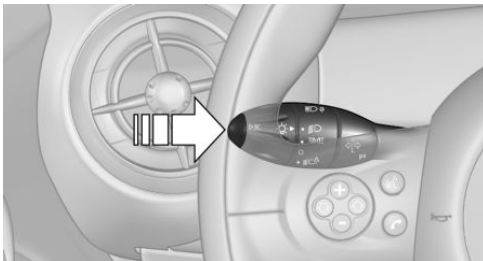

3. Press and hold the button until the display changes.

4. Press the button repeatedly until the corresponding symbol and "SERVICE-INFO" are displayed.







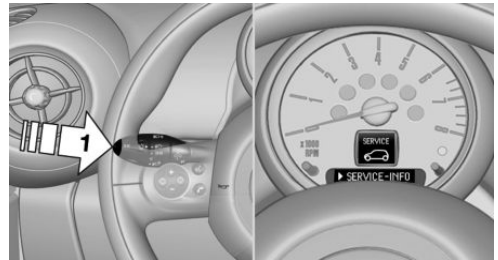







5. Press and hold the button until the display changes.
6. Press the button to display the individual service requirement items.

### Possible displays



- 1 Button for selecting the information.

Symbol	Function
	Service requirements
	Engine oil

Symbol	Function
	Roadworthiness test
	
	Front brake pads
	
	Rear brake pads
	
	Brake fluid
	
	Exit the display, refer to page 61
	
	Next setting or information, refer to page 61
	

## Indicator/warning lamps

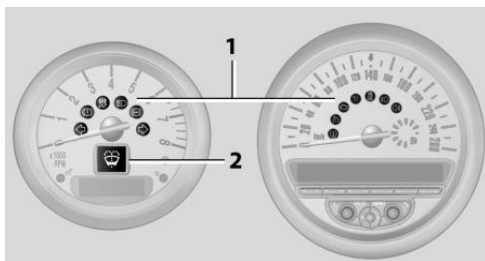

The indicator and warning lamps can light up in a variety of combinations and colors in display area 1 or 2.

Several of the lamps are checked for proper functioning and light up temporarily when the engine is started or the ignition is switched on.

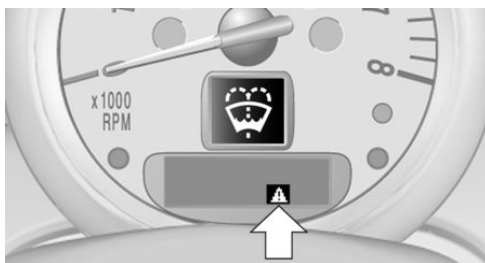

⚠ The symbol indicates that Check Control messages have been stored. The Check Control messages can be displayed later.

## What to do in case of a malfunction

The meaning of each lamp in the event of a malfunction and tips on how to respond are provided in the list, refer to page 191.

## CHECK CONTROL

### The concept

The Check Control monitors vehicle functions and alerts you to any malfunctions in the systems being monitored.

A Check Control message consists of indicator and warning lamps in the instrument cluster and, in some circumstances, an acoustic signal.

## Hiding Check Control messages

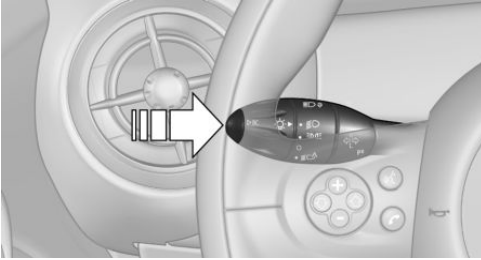

Press the button on the turn indicator lever.

Some Check Control messages are displayed continuously and are not cleared until the malfunction is eliminated. If several malfunctions occur at once, the messages are displayed consecutively.

Other Check Control messages are hidden automatically after approx. 20 seconds. However, they are stored and can be displayed again later.

## Viewing stored Check Control messages

The stored Check Control messages can only be displayed while the driver's door is closed.

1. Press the button on the turn indicator lever repeatedly until "SET/INFO" is displayed.

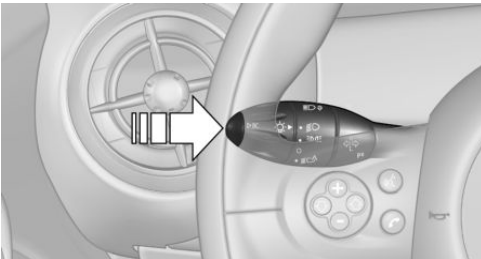

2. Press and hold the button until the display changes.

3. Press the button repeatedly until the corresponding symbol and "CHECK INFO" appear on the display.



4. Press and hold the button.  
If there is no Check Control message, this is indicated by "CHECK OK".  
If a Check Control message has been stored, the corresponding message is displayed.
5. Press the button to check for other messages.

# LAMPS

## VEHICLE EQUIPMENT

This chapter describes all series equipment as well as country-specific and special equipment offered for this model series. Therefore, it also describes equipment that may not be found in your vehicle, for instance due to the selected special equipment or the country version. This also applies to safety-related functions and systems.

When using the features and systems described here, adhere to local regulations.

## AT A GLANCE

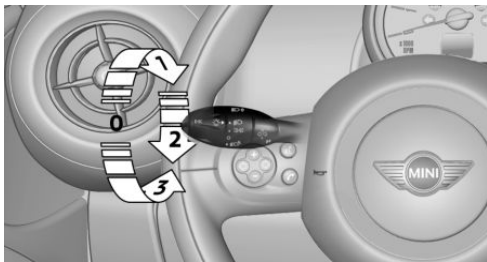

- 0 Lamps off / daytime running lights
- 1 Parking lights and daytime running lights
- 2 Low-beam headlights and welcome lights
- 3 Automatic headlight control, Adaptive Light Control, daytime running lights, and welcome lights

## PARKING LIGHTS/LOW BEAMS, HEADLIGHT CONTROL

### General information

When the driver's door is opened with the ignition switched off, the exterior lighting is auto-

matically switched off when the light switch is in position 0, 2, or 3.

Switch on the parking lights if necessary, switch position 1.

### Parking lights

Switch position 1: the vehicle lights light up on all sides.

Do not use the parking lights for extended periods; otherwise, the battery may become discharged and it would then be impossible to start the engine.

When parking, it is preferable to switch on the one-sided roadside parking lights, refer to page 67.

### Low beams

Switch position 2: the low beams are lit when the ignition is switched on.

### Automatic headlight control

Switch position 3: the low beams are switched on and off automatically depending on the ambient light, e.g., in tunnels, in twilight, or if there is precipitation. Adaptive Light Control is active.

A blue sky with the sun low on the horizon can cause the lights to be switched on.

The low beams remain switched on independent of the ambient lighting conditions when you switch on the front fog lights.



Personal responsibility

The automatic headlamp control cannot serve as a substitute for your personal judgment in determining when the lamps should be switched on in response to ambient lighting conditions.

For example, the sensors are unable to detect fog or hazy weather. To avoid safety risks, you should always switch on the lamps manually under these conditions. ◀

The exterior lighting goes out automatically after the vehicle is switched off.

### High-beams/roadside parking lights

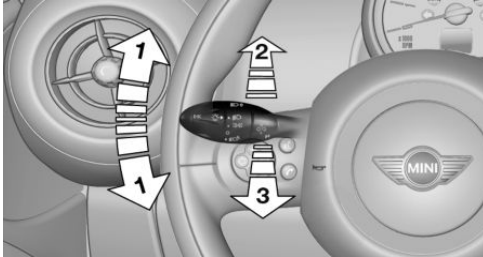

- 1 Turn signal/roadside parking light
- 2 Switching on the high-beams
- 3 Switching off the high-beams/headlight flasher

To assist in parking, the vehicle can be illuminated on one side; note the country-specific regulations.

The roadside parking lights drain the battery. Therefore, do not leave them on for unduly long periods of time; otherwise, the battery might not have enough power to start the engine.

### Switching on the roadside parking light

To switch on the roadside parking light on the left or right, press the turn indicator lever up or down after switching off the vehicle, arrow 1.

### Switching off the roadside parking light

Press the lever up or down to the resistance point.

### Daytime running lights

The daytime running lights light up in switch position 0, 1, or 3 when the ignition is switched on.

The exterior lighting goes out automatically after the vehicle is switched off.

In switch position 1, the parking lights light up after the ignition is switched off.

### Activating/deactivating

In some countries, driving with daytime running lights is mandatory; for this reason, daytime running lights cannot be deactivated in these cases.

1. Switch on the ignition, refer to page 48.
2. Press the button on the turn indicator lever repeatedly until "SET/INFO" is displayed.

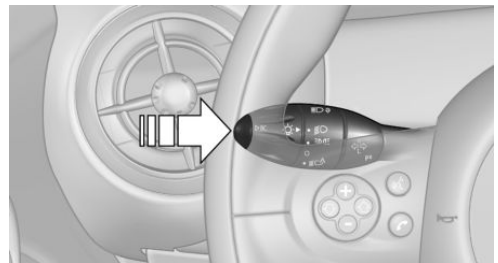

3. Press and hold the button until the display changes.
4. Press the button repeatedly until the symbol and "SET" are displayed.

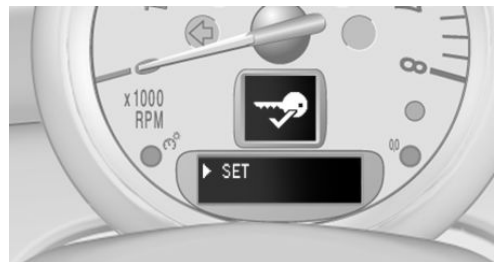

5. Press and hold the button until the display changes.

- Press the button repeatedly until the symbol shown is displayed, arrow.

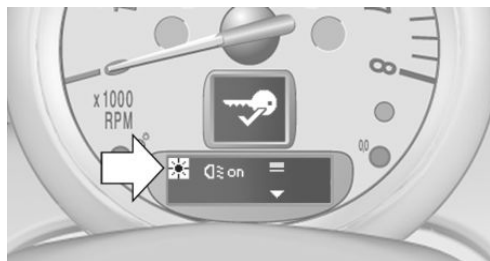

- Press and hold the button until the display changes.
- Press the button to select:
  - ▷ **Qz on**  
Daytime running lights are activated.
  - ▷ **Qz off**  
Daytime running lights are deactivated.
- Hold the button down.

The setting is stored for the remote control currently in use.

### Welcome lights

If the light switch stays in switch position 2 or 3 after the vehicle is switched off, the parking lights and the interior lights light up for a certain period when the vehicle is unlocked.

### Headlight courtesy delay feature

The low beams stay lit for a short while after the ignition is switched off, if the lights are switched off and the headlight flasher is switched on.

### Setting the duration

- Switch on the ignition.
- Press the button on the turn indicator lever repeatedly until "SET/INFO" is displayed.
- Press and hold the button until the display changes.

- Press the button repeatedly until the symbol and "SET" are displayed.

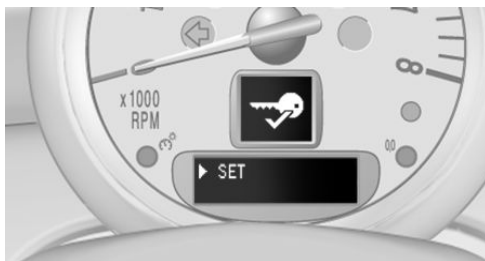

- Press and hold the button until the display changes.
- Press the button repeatedly until the symbol shown is displayed, arrow.

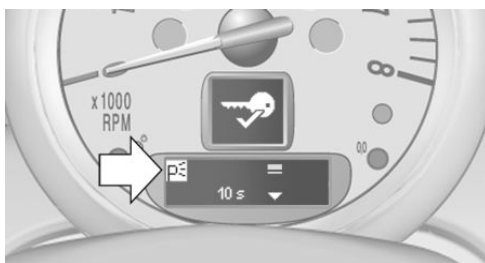

- Press and hold the button until the display changes.
- Press the button to select:
  - ▷ **0 s**  
The function is deactivated.
  - ▷ **10 s ... 240 s**  
Select the duration, e.g. 40 seconds.
- Hold the button down.

The setting is stored for the remote control currently in use.

## ADAPTIVE LIGHT CONTROL

### The concept

Adaptive Light Control is a variable headlight control system that enables dynamic illumination of the road surface.

Depending on the steering angle and other parameters, the light from the headlight follows the course of the road.

### Activating

With the ignition switch on, turn the light switch to position 3, refer to page 66.

To avoid blinding oncoming traffic, the Adaptive Light Control does not swivel to the driver's side when the vehicle is at a standstill.

When driving in reverse, Adaptive Light Control is not active.

### Malfunction



The warning light lights up. Adaptive Light Control is malfunctioning or has failed. Have the system checked as soon as possible.

More information, refer to page 191.

## FOG LIGHTS

### At a glance

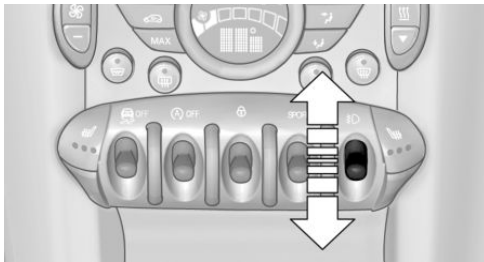

To switch on the front fog lights: press the switch.

To switch off, press the respective switch upward or downward again.

### Fog lights

The parking lights or low beams must be switched on. The green indicator lamp lights up when the front fog lights are switched on.

Depending on the vehicle equipment, the front fog lights are switched off when the headlight flasher or the high-beams are activated.

If the automatic headlight control is activated, refer to page 66, the low beams are switched on automatically when the front fog lights are switched on.

## INSTRUMENT LIGHTING

The parking lights or low beams must be switched on to adjust the brightness. The brightness is increased to a certain limit and is then reduced again.

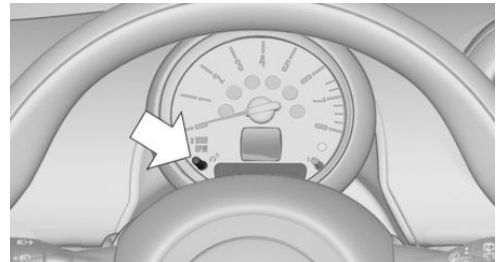

- ▷ Press the button briefly: the brightness changes in stages.
- ▷ Press and hold the button: the brightness changes continuously.

## INTERIOR LIGHTS

The interior lights, the footwell lights and the cargo area light are controlled automatically.

To avoid draining the battery, all lights inside the vehicle are switched off some time after the ignition is switched off.

## Switching interior lights on/off manually

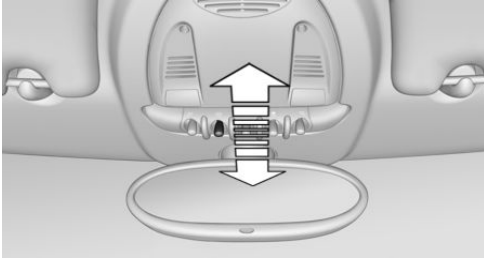

To switch the interior lights on/off: press the switch.

If the interior lights are to remain switched off, press the switch for approx. 3 seconds.

## Reading lights

Reading lights are located in the front next to the interior light and in the rear.

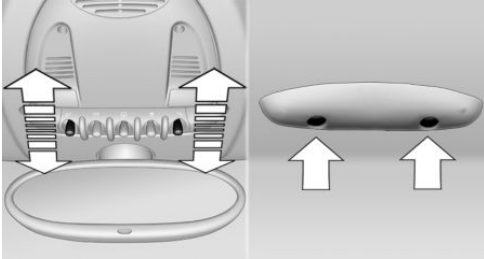

Switching the reading lights on/off

Front: press the switch.

Rear: press the button.

## Ambient lighting

The color and brightness of the ambient lighting can be changed.

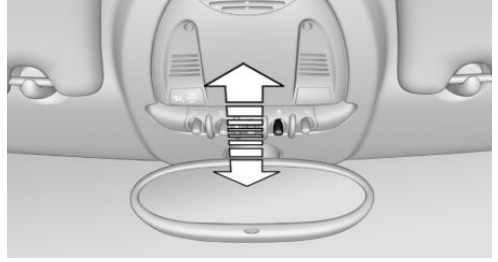

Press the switch forward: the color changes in steps.

Press the switch back: the brightness changes in steps.

Intermediate settings and intermediate colors are possible.

For continuously changing colors of the ambient lighting, press the switch forward for more than 10 seconds.

For Canadian vehicles:

Continuously changing colors of the ambient lighting is not available.



# SAFETY

## VEHICLE EQUIPMENT

This chapter describes all series equipment as well as country-specific and special equipment offered for this model series. Therefore, it also describes equipment that may not be found in your vehicle, for instance due to the selected special equipment or the country version. This also applies to safety-related functions and systems.

When using the features and systems described here, adhere to local regulations.

## AIRBAGS

The graphic shows the MINI Paceman as an example.

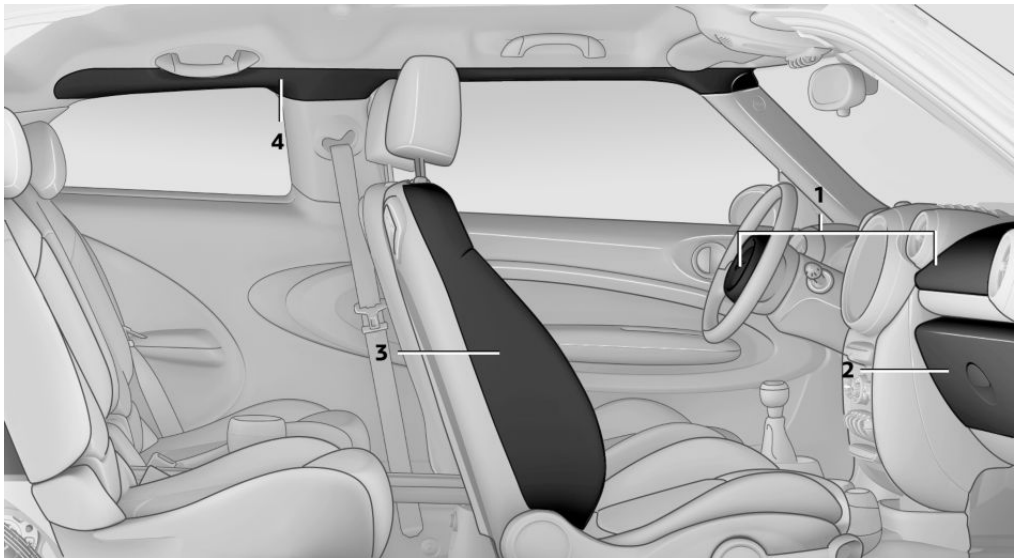

1 Front airbags

2 Knee airbag

3 Side airbag

4 Head airbags

### Front airbags

Front airbags help protect the driver and front passenger by responding to frontal impacts in which safety belts alone cannot provide adequate restraint.

### Head airbags

In a lateral impact, the head airbag supports the head.

### Side airbags

In a lateral impact, the side airbag supports the side of the body in the chest and lap area.

### Knee airbag

The knee airbag supports the legs in a frontal impact.

## Protective action

Airbags are not triggered in every impact situation, e.g., in less severe accidents or rear-end collisions.

 Information on how to ensure the optimal protective effect of the airbags

- ▷ Keep at a distance from the airbags.
- ▷ Always grasp the steering wheel on the steering wheel rim, holding your hands at the 3 o'clock and 9 o'clock positions, to keep the danger of injury to your hands or arms as low as possible if the airbag is triggered.
- ▷ There should be no people, animals, or objects between an airbag and a person.
- ▷ Do not use the cover of the front airbag on the front passenger side as a storage area.
- ▷ Keep the dashboard and window on the front passenger side clear, i.e., do not cover with adhesive labels or coverings, and do not attach holders or cables such as for navigation instruments and mobile phones.
- ▷ Make sure that the front passenger is sitting correctly, i.e., keeps his or her feet and legs in the footwell; otherwise, leg injuries can occur if the front airbag is triggered.
- ▷ Do not place slip covers, seat cushions or other objects on the front passenger seat that are not approved specifically for seats with integrated side airbags.
- ▷ Do not hang pieces of clothing, such as jackets, over the backrests.
- ▷ Make sure that occupants keep their heads away from the side airbag and do not rest against the head airbag; otherwise, injuries can occur if the airbags are triggered.
- ▷ Do not remove the airbag restraint system.
- ▷ Do not remove the steering wheel.
- ▷ Do not apply adhesive materials to the airbag cover panels, cover them or modify them in any way.

- ▷ Never modify either the individual components or the wiring in the airbag system. This also applies to steering wheel covers, the dashboard, the seats, the roof pillars and the sides of the headliner. ◀

Even when all instructions are followed closely, injury from contact with the airbags cannot be ruled out in certain situations.

The ignition and inflation noise may lead to short-term and, in most cases, temporary hearing impairment in sensitive individuals.

 In the case of a malfunction, deactivation and after triggering of the airbags

Do not touch the individual components immediately after the system has been triggered; otherwise, there is the danger of burns.

Only have the airbags checked, repaired or dismantled and the airbag generator scrapped by your service center or a workshop that has the necessary authorization for handling explosives.

Non-professional attempts to service the system could lead to failure in an emergency or undesired triggering of the airbag, either of which could result in injury. ◀

Warning notices and information about the airbags can also be found on the sun visors.

## Automatic deactivation of the front passenger airbags

The system determines whether the front passenger seat is occupied by measuring the electrical resistance of the human body.

The front, side, and knee airbags on the front passenger side are activated or deactivated accordingly by the system.

The indicator lamp above the interior rearview mirror, refer to page 73, shows the current status of the front passenger airbags, deactivated or activated.

**Leave feet in the footwell**

Make sure that the front passenger keeps his or her feet in the footwell; otherwise, the front passenger airbags may not function properly. ◀

**Child restraint fixing system in the front passenger seat**

Before transporting a child on the front passenger seat, read the safety and operating instructions under Transporting children safely, refer to page 43. ◀

**Malfunction of the automatic deactivation system**

When transporting older children and adults, the front passenger airbags may be deactivated in certain sitting positions. In this case, the indicator lamp for the front passenger airbags lights up.

In this case, change the sitting position so that the front passenger airbags are activated and the indicator lamp goes out.

If it is not possible to activate the airbags, have the person sit in the rear.

To make sure that occupation of the seat cushion can be detected correctly:

- ▷ Do not attach seat covers, seat cushion padding, ball mats, or other items to the front passenger seat unless they are specifically recommended by the manufacturer of your MINI.
- ▷ Do not place electronic devices on the passenger seat if a child restraint fixing system is mounted on the seat.
- ▷ Do not place objects under the seat that could press against the seat from below.

**Indicator light for the front passenger airbags**

The indicator lamp for the front passenger airbags indicates the operating state of the front passenger airbags.

The light indicates whether the airbags are activated or deactivated.



- ▷ The indicator lamp lights up when a child who is properly seated in a child restraint fixing system intended for that purpose is detected on the seat or the seat is empty. The airbags on the front passenger side are not activated.
  - ▷ The indicator lamp does not light up when, for example, a correctly seated person of sufficient size is detected on the seat. The airbags on the front passenger side are activated.
- Most child seats are detected by the system. Especially the child seats required by NHTSA at the time that the vehicle was manufactured. After installing a child seat, make sure that the indicator lamp for the front passenger airbags lights up. This indicates that the child seat has been detected and the front passenger airbags are not activated.

## Operational readiness of airbag system



 In the radio ready state and beyond, refer to page 48, the warning light lights up briefly to indicate that the entire airbag system and the belt tensioners are operational.

## Airbag system malfunction

- ▷ Warning light does not light up in the radio ready state.
- ▷ Warning light remains permanently on.

 Have the airbag system checked without delay if there is a malfunction

In the event of a malfunction in the airbag system, have it checked without delay; otherwise, there is the risk that the system will not function as intended even if a sufficiently severe accident occurs.◀

## FTM FLAT TIRE MONITOR

### The concept

The system does not measure the actual inflation pressure in the tires.

The system detects a pressure loss in a tire by comparing the rotational speeds of the individual wheels while moving.

In the event of a pressure loss, the diameter and therefore the rotational speed of the corresponding wheel change. This is detected and reported as a flat tire.

## Functional requirements

The system must have been initialized when the tire inflation pressure was correct; otherwise, reliable signaling of a flat tire is not ensured.

Initialize the system after each correction of the tire inflation pressure and after every tire or wheel change.

## System limits



Sudden tire damage

Sudden serious tire damage caused by external influences cannot be indicated in advance.◀

A natural, even pressure loss in all four tires cannot be detected. Therefore, check the tire inflation pressure regularly.

The system could be delayed or malfunction in the following situations:

- ▷ When the system has not been initialized.
- ▷ When driving on a snowy or slippery road surface.
- ▷ Sporty driving style: slip in the drive wheels, high lateral acceleration.
- ▷ When driving with snow chains.

## Initialization

The initialization process adopts the set inflation tire pressures as reference values for the detection of a flat tire. Initialization is started by confirming the inflation pressures.

Do not initialize the system when driving with snow chains.

1. Start the engine, but do not start driving.
2. Press the button on the turn indicator lever repeatedly until "SET/INFO" is displayed.

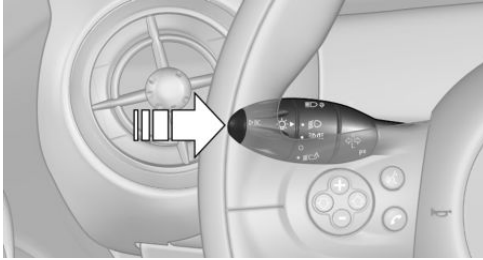

3. Press and hold the button until the display changes.
4. Press the button repeatedly until the corresponding symbol and "RESET" are displayed.

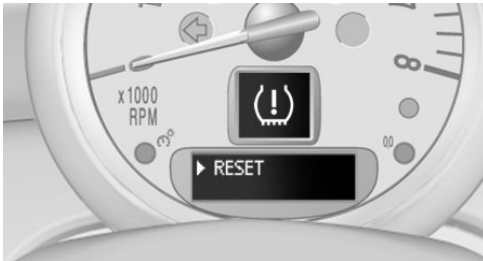

5. Press and hold the button until the display changes.
6. Drive away.

Initialization is completed while the car is traveling without feedback being given.

### Indication of a flat tire

 The warning lights come on in yellow and red. In addition, a signal sounds.



There is a flat tire or a major loss in tire inflation pressure.

1. Reduce your speed and stop cautiously. Avoid sudden braking and steering maneuvers.
2. Check whether the vehicle is fitted with regular tires or run-flat tires.

Run-flat tires, refer to page 160, are labeled with a circular symbol containing the letters RSC marked on the tire sidewall.

 Do not continue driving without run-flat tires

Do not continue driving if the vehicle is not equipped with run-flat tires; continued driving may result in serious accidents. ◀

When a flat tire is indicated, DSC Dynamic Stability Control is switched on if necessary.

### Actions in the event of a flat tire

#### Normal tires

1. Identify the damaged tire.

Do this by checking the inflation pressure in all four tires.

The tire pressure gauge of the Mobility System, refer to page 161, can be used for this purpose.

If the tire inflation pressure in all four tires is correct, the Flat Tire Monitor may not have been initialized. In this case, initialize the system.

If an identification is not possible, please contact the service center.

2. Rectify the flat tire using the Mobility System, refer to page 161.

#### Run-flat tires

You can continue driving with a damaged tire at speeds up to 50 mph/80 km/h.

## Continued driving with a flat tire

If continuing to drive with a damaged tire:

1. Avoid sudden braking and steering maneuvers.
2. Do not exceed a speed of 50 mph/80 km/h.
3. At the next opportunity, check the inflation pressure in all four tires.

If the tire inflation pressure in all four tires is correct, the Flat Tire Monitor may not have been initialized. In this case, initialize the system.

Possible driving distance with complete loss of tire inflation pressure:

The possible driving distance after a loss of tire inflation pressure depends on the cargo load and the driving style and conditions.

For a vehicle containing an average load, the possible driving distance is approx. 50 miles/80 km.

When the vehicle is driven with a damaged tire, its handling characteristics change, e.g., reduced lane stability during braking, a longer braking distance, and altered self-steering properties. Adjust your driving style accordingly. Avoid abrupt steering maneuvers or driving over obstacles, e. g., curbs, potholes, etc.

Because the possible driving distance depends on how the vehicle is used during the trip, the actual distance may be smaller or greater depending on the driving speed, road conditions, external temperature, cargo load, etc.

### Continued driving with a flat tire

Drive moderately and do not exceed a speed of 50 mph/80 km/h.

A loss of tire inflation pressure results in a change in the handling characteristics, e.g., reduced lane stability during braking, a longer braking distance and altered self-steering properties. ◀



### Final tire failure

Vibrations or loud noises while driving can indicate the final failure of the tire. Reduce speed and stop; otherwise, pieces of the tire could come loose and cause an accident. Do not continue driving, and contact your service center. ◀

## TIRE PRESSURE MONITOR TPM

### The concept

The system monitors the tire pressure in the four mounted tires. The system notifies you if there is a significant loss of pressure in one or more tires. Sensors in the tire valves measure the tire pressure.

### Notes



Tire damage caused by external influences

Sudden tire damage caused by external influences cannot be indicated in advance. ◀

To operate the system, also note the additional information and instructions contained under Tire inflation pressure, refer to page [152](#).

### Functional requirements

The system must have been reset while the inflation pressure was correct; otherwise, it may not reliably signal a loss in pressure.

Perform a system reset after adjusting the tire inflation pressure to a new value and after changing a tire or wheel

Always use wheels with TPM electronics to ensure that the system will operate properly.

## Performing a reset

Perform a system reset after adjusting the tire inflation pressure to a new value and after changing a tire or wheel.

1. Start the engine, but do not start driving.
2. Press the button on the turn indicator lever repeatedly until "SET/INFO" is displayed.

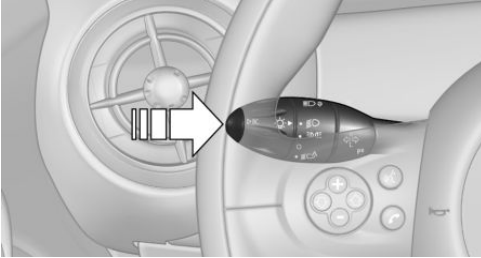

3. Press and hold the button until the display changes.
4. Press the button repeatedly until the symbol for the Tire Pressure Monitor and "ACTIVE" are displayed. The Tire Pressure Monitor can be reset with "RESET".



5. Press and hold the button until "RESETTING" is displayed.

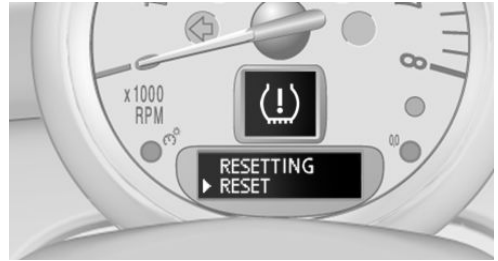

6. Drive away.

After a short trip at over 20 mph/30 km/h, the set tire inflation pressures are adopted as target values. The reset is completed automatically as you drive.

The trip can be interrupted at any time. When driving resumes, the reset is continued automatically.

## Low tire pressure message



The warning lights come on in yellow and red. A Check Control message is displayed. In addition, a signal sounds.



- ▷ There is a flat tire or substantial loss of inflation pressure on the indicated wheel.
- ▷ The system was not reset after a wheel change and thus issues warnings based on the inflation pressures initialized last.

1. Reduce your speed and stop cautiously. Avoid sudden braking and steering maneuvers.
2. Check whether the vehicle is fitted with regular tires or run-flat tires.

Run-flat tires, refer to page 160, are labeled on the tire sidewall with a circular symbol containing the letters RSC.

 Do not continue driving without run-flat tires

Do not continue driving if the vehicle is not equipped with run-flat tires; continued driving may result in serious accidents. ◀

When a low inflation pressure is indicated, DSC Dynamic Stability Control is switched on if necessary.

## Actions in the event of a flat tire

### Normal tires

1. Identify the damaged tire.

Do this by checking the air pressure in all four tires. The tire pressure gauge of the Mobility System, refer to page 161, can be used for this purpose.

If the tire inflation pressure in all four tires is correct, the Tire Pressure Monitor may not have been reset. Reset the system.

If an identification is not possible, please contact the service center.

2. Rectify the flat tire using the Mobility System, refer to page 161.

Use of tire sealant, e.g., the Mobility System, may damage the TPM wheel electronics. In this case, have the electronics checked at the next opportunity and have them replaced if necessary.

### Run-flat tires

You can continue driving with a damaged tire at speeds up to 50 mph/80 km/h.

 Do not continue driving without run-flat tires

Do not continue driving if the vehicle is not equipped with run-flat tires; continued driving may result in serious accidents. ◀

## Continued driving with a flat tire

If continuing to drive with a damaged tire:

1. Avoid sudden braking and steering maneuvers.
2. Do not exceed a speed of 50 mph/80 km/h.
3. Check the air pressure in all four tires at the next opportunity.

If the tire inflation pressure in all four tires is correct, the Tire Pressure Monitor may not have been reset. Reset the system.

Possible driving distance with complete loss of tire inflation pressure:

The possible driving distance after a loss of tire inflation pressure depends on the cargo load and the driving style and conditions.

For a vehicle containing an average load, the possible driving distance is approx. 50 miles/80 km.

When the vehicle is driven with a damaged tire, its handling characteristics change, e.g., reduced lane stability during braking, a longer braking distance, and altered self-steering properties. Adjust your driving style accordingly. Avoid abrupt steering maneuvers or driving over obstacles, e.g., curbs, potholes, etc.

Because the possible driving distance depends on how the vehicle is used during the trip, the actual distance may be smaller or greater depending on the driving speed, road conditions, external temperature, cargo load, etc.

 Continued driving with a flat tire

Drive moderately and do not exceed a speed of 50 mph/80 km/h.

A loss of tire inflation pressure results in a change in the handling characteristics, e.g., reduced lane stability during braking, a longer braking distance and altered self-steering properties. ◀



**Final tire failure**

Vibrations or loud noises while driving can indicate the final failure of the tire. Reduce speed and stop; otherwise, pieces of the tire could come loose and cause an accident. Do not continue driving, and contact your service center. ◀

**Message indicating that the inflation pressure needs to be checked**

The yellow warning light lights up.

A Check Control message is displayed.

- ▷ The system has detected that a wheel was changed but a reset was not performed.
- ▷ The tire was not inflated according to specifications.
- ▷ The tire pressure has dropped since the last confirmation.

In this case:

- ▷ Check the tire inflation pressure and correct it if necessary.
- ▷ After changing a wheel, reset the system.

**System limits**

The system will not function properly if a reset was not performed, e.g., it may identify a tire as flat although the tire is filled to the correct inflation pressure.

The tire pressure depends on the temperature of the tire. An increase in the tire temperature, e.g., while driving or due to sunlight, increases the tire inflation pressure. The tire pressure decreases when the tire temperature drops. In case of severe temperature drops, this behavior may lead to a warning on account of the defined warning limits.

**Malfunction**

The yellow warning light flashes yellow and then lights up continuously.



A Check Control message is displayed.

A flat tire or tire inflation pressure loss cannot be detected.

Display in the following situations:

- ▷ A wheel without TPM electronics is mounted, e.g., a compact wheel:
  - Have the system checked by the service center if necessary.
- ▷ Malfunction:
  - Have the system checked by the service center.
- ▷ TPM was unable to complete the reset.
  - Reset the system again.



The yellow warning light flashes and then lights up continuously.



A Check Control message is displayed.

A flat tire or tire inflation pressure loss cannot be detected.

Display in the following situation:

- ▷ Disturbance by other systems or devices with the same radio frequency:
  - After leaving the area of the disturbance, the system automatically becomes active again.

**Declaration according to NHTSA/FMVSS 138 Tire Pressure Monitoring Systems**

Each tire, including the spare (if provided) should be checked monthly when cold and inflated to the inflation pressure recommended by the vehicle manufacturer on the vehicle placard or tire inflation pressure label (If your vehicle has tires of a different size than the size indicated on the vehicle placard or tire inflation pressure label, you should determine the proper tire inflation pressure for those tires.).

As an added safety feature, your vehicle has been equipped with a tire pressure monitoring system (TPMS) that illuminates a low tire pressure telltale when one or more of your tires is significantly under-inflated. Accordingly, when the low tire pressure telltale illuminates, you

should stop and check your tires as soon as possible, and inflate them to the proper pressure. Driving on a significantly under-inflated tire causes the tire to overheat and can lead to tire failure. Under-inflation also reduces fuel efficiency and tire tread life, and may affect the vehicle's handling and stopping ability.

Please note that the TPMS is not a substitute for proper tire maintenance, and it is the driver's responsibility to maintain correct tire pressure, even if under-inflation has not reached the level to trigger illumination of the TPMS low tire pressure telltale.

Your vehicle has also been equipped with a TPMS malfunction indicator to indicate when the system is not operating properly. The TPMS malfunction indicator is combined with the low tire pressure telltale. When the system detects a malfunction, the telltale will flash for approximately one minute and then remain continuously illuminated. This sequence will continue upon subsequent vehicle startups as long as the malfunction exists. When the malfunction indicator is illuminated, the system may not be able to detect or signal low tire pressure as intended. TPMS malfunctions may occur for a variety of reasons, including the installation of replacement or alternate tires or wheels on the vehicle that prevent the TPMS from functioning properly. Always check the TPMS malfunction telltale after replacing one or more tires or wheels on your vehicle to ensure that the replacement or alternate tires and wheels allow the TPMS to continue to function properly.

# DRIVING STABILITY CONTROL SYSTEMS

## VEHICLE EQUIPMENT

This chapter describes all series equipment as well as country-specific and special equipment offered for this model series. Therefore, it also describes equipment that may not be found in your vehicle, for instance due to the selected special equipment or the country version. This also applies to safety-related functions and systems.

When using the features and systems described here, adhere to local regulations.

## ANTILOCK BRAKE SYSTEM ABS

ABS prevents locking of the wheels during braking.

Steerability is maintained even during full braking. This increases active driving safety.

ABS is operational every time you start the engine.

### Electronic brake-force distribution EBV

The system controls the brake pressure in the rear wheels to ensure stable braking behavior.

### CBC Cornering Brake Control

When braking in curves or during a lane change, driving stability and steering response are improved further.

## BRAKE ASSISTANT

When the brakes are applied rapidly, this system automatically produces the maximum braking force boost. In this way, the system helps keep the braking distance as short as

possible. This system utilizes all of the benefits provided by ABS.

Do not reduce the pressure on the brake pedal for the duration of full braking.

## DYNAMIC STABILITY CONTROL DSC

### The concept

DSC prevents traction loss in the driving wheels when driving away and accelerating.

DSC also recognizes unstable vehicle conditions, such as fishtailing or nose-diving. Subject to physical limits, DSC helps to keep the vehicle on a steady course by reducing engine speed and by applying brakes to the individual wheels.

DSC is operational every time you start the engine.



Adjust your driving style to the situation

An appropriate driving style is always the responsibility of the driver.

The laws of physics cannot be repealed, even with DSC.

Do not reduce the additional safety margin with a risky driving style, as otherwise there is a risk of an accident. ◀

## Deactivating DSC

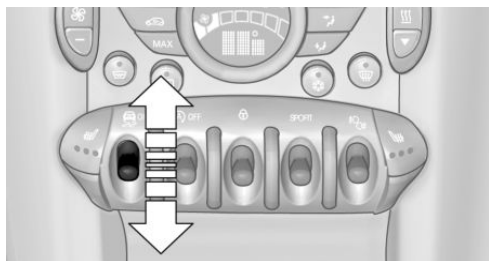

Press the switch until the DSC OFF indicator lamp lights up in the speedometer and DSC OFF appears in the tachometer. DSC is deactivated. Intervening measures to stabilize the vehicle and give it forward momentum are no longer executed.

When driving with snow chains or to rock the vehicle free of snow, it may be useful to deactivate DSC temporarily.

To increase vehicle stability, activate DSC again as soon as possible.

## Activating DSC

Press the switch again; the DSC indicator lamps in the display elements go out.

## Indicator/warning lights



The indicator lamp in the tachometer flashes: DSC is controlling the drive forces and brake forces.

The indicator lamp lights up: DSC and DTC has failed.



The indicator lamp in the speedometer lights up and DSC OFF appears in the tachometer.

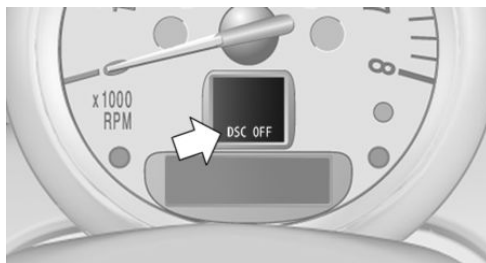

DSC and DTC deactivated.

## DYNAMIC TRACTION CONTROL DTC

### The concept

The DTC system is a version of the DSC in which forward momentum is optimized.

The system ensures maximum forward momentum on special road conditions, e.g., unplowed snowy roads, but driving stability is limited.

It is therefore necessary to drive with appropriate caution.

You may find it useful to briefly activate DTC under the following special circumstances:

- ▷ When driving in sand, on snowy inclines, in slush, or on unplowed, snow-covered road surfaces
- ▷ When rocking a vehicle free or starting off in deep snow, sand, or on loose ground
- ▷ When driving with snow chains.

## Activating DTC

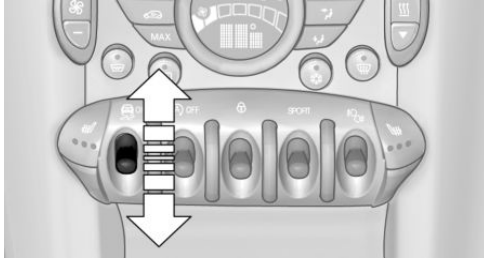

Press the switch; the DSC OFF indicator lamp lights up in the speedometer and TRACTION appears in the tachometer. Dynamic Stability Control DSC is deactivated, Dynamic Traction Control DTC is activated.

## Deactivating DTC

Press the switch again; the DSC OFF indicator lamp in the speedometer and TRACTION in the tachometer go out.

In the interest of better forward momentum, brake intervention is performed in the manner of a differential lock when the drive wheels spin unevenly even when DSC/DTC is deactivated.

## Indicator/warning lamps



The indicator lamp in the tachometer flashes: DTC is controlling the drive forces and brake forces.

The indicator lamp lights up: DSC and DTC has failed.



The indicator lamp in the speedometer lights up and TRACTION appears in the tachometer.

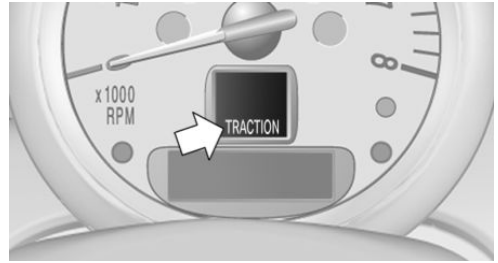

DTC is activated.

## HILL DRIVE-OFF ASSISTANT

This system supports driving away on gradients. The parking brake is not required.

1. Hold the vehicle in place with the foot brake.
2. Release the foot brake and drive away without delay.



Driving off without delay

After releasing the foot brake, start driving without delay, since the drive-off assistant will not hold the vehicle in place for more than approx. 2 seconds and the vehicle will begin rolling back. ◀

## ALL4 ALL-WHEEL SYSTEM

ALL4 is the all-wheel system of your MINI. The combined effects of ALL4 and DSC further optimize the traction and dynamic driving characteristics. The ALL4 all-wheel system variably distributes the drive forces to the front and rear axles depending on the driving situation and prevailing road conditions.

## SPORT BUTTON

When this button is pressed, the vehicle responds in an even sportier manner.

- ▷ The engine responds more spontaneously to accelerator movements.
- ▷ The steering responds more directly.
- ▷ Cooper S, John Cooper Works: the engine sounds sportier when coasting.
- ▷ For Steptronic transmissions: more rapid gear changes in the Sport program.

### Activating the system

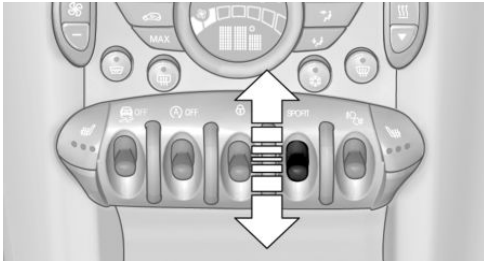

Press the switch; the LED in the button lights up and SPORT is displayed briefly in the tachometer.

### Deactivating the system

- ▷ Press the switch again.
- ▷ Switch the engine off.

# DRIVING COMFORT

## VEHICLE EQUIPMENT

This chapter describes all series equipment as well as country-specific and special equipment offered for this model series. Therefore, it also describes equipment that may not be found in your vehicle, for instance due to the selected special equipment or the country version. This also applies to safety-related functions and systems.

When using the features and systems described here, adhere to local regulations.

## CRUISE CONTROL

### The concept

The system is functional at speeds beginning at approx. 20 mph/30 km/h.

The vehicle stores and maintains the speed specified using the controls on the steering wheel.



Do not use cruise control

Do not use the system if unfavorable conditions make it impossible to drive at a constant speed, for instance:

- ▷ On curvy roads.
- ▷ In heavy traffic.
- ▷ On slippery roads, in fog, snow or rain, or on a loose road surface.

Otherwise, you could lose control of the vehicle and cause an accident. ◀

## Controls

### At a glance

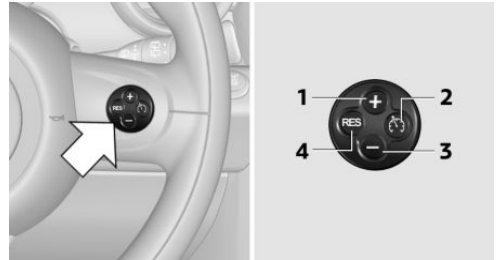

- 1 Maintaining, storing, and increasing the speed
- 2 Activating/deactivating cruise control
- 3 Maintaining, storing, and reducing the speed
- 4 Resuming cruise control

### Switching on

Press button 2.



The indicator lamp lights up in the speedometer. Cruise control is ready to operate and can be activated.

### Switching off

Press button 2.

- ▷ When activated: press twice.
- ▷ When interrupted: press once.

The displays go out. The stored target speed is cleared.

### Interrupting

Press button 2.

The system is interrupted automatically if

- ▷ The brakes are applied.
- ▷ The clutch pedal is depressed.

- ▷ The transmission position D is disengaged.
- ▷ DSC intervenes.

### Maintaining, storing the current speed

Press button 1 or button 3.

The current speed is maintained and stored. It is displayed briefly in the tachometer.

On downhill gradients, it may prove impossible to maintain the set speed if the engine braking power is insufficient. On uphill gradients, it may prove impossible to maintain the set speed if the engine power output is insufficient.

### Increasing speed

- ▷ Press button 1 repeatedly until the desired speed is reached.

Each time the button is pressed, the speed increases by approx. 1 mph/1 km/h.

- ▷ Press and hold button 1 until the desired speed is reached.

The vehicle accelerates without pressure on the accelerator pedal. After the button is released, the achieved speed is maintained and stored.

### Decreasing speed

Press button 3 repeatedly or hold it until the desired speed is reached.

The functions are the same those when the speed is increased, only that the speed is reduced.

### Resuming a speed stored beforehand

Press button 4.

The last stored speed is resumed and maintained.

The stored speed is cleared when the ignition is switched off.

### Display in the tachometer



The selected speed is displayed briefly.

If the display --- mph or --- km/h appears briefly, conditions may not be adequate to operate the system.

### For better control



The indicator lamp lights up in the speedometer. Cruise control is ready to operate and can be activated.

### Malfunction



The warning lamp in the tachometer lights up.

The system is malfunctioning or has failed.

## PARK DISTANCE CONTROL PDC

### The concept

PDC provides support when parking in reverse. Signal tones indicate that the vehicle is approaching an object behind it. Measurements are made by four ultrasound sensors in the bumpers.

The range of these sensors is approx. 6 ft/2 m.

An acoustic warning is first given:

- ▷ By the two corner sensors at approx. 24 in/60 cm.



- ▷ By the rear middle sensors at approx. 5 ft/1.50 m.



Avoid driving quickly with PDC

PDC is a parking aid that can display objects when the vehicle approaches them slowly, as is the case during parking maneuvers. Avoid driving toward an object quickly as the system may then be too late in issuing a warning for technical reasons. ◀

### Automatic operation

The system is activated after approx. one second when reverse gear or selector lever position R is engaged while the engine is running or the ignition is switched on. Await this short period before setting the vehicle into motion.

### Signal tones

The closer the vehicle is to the object, the shorter the intervals become. If the distance to a detected object is less than approx. 12 in/30 cm, a continuous tone is sounded.

If the distance remains constant, for example when driving parallel to a wall, the signal tone is stopped after approx. 3 seconds.

### Volume

The signal tone volume can be adjusted. Radio MINI Boost CD, refer to page [124](#).

### System limits



Check the traffic situation as well

PDC cannot serve as a substitute for the driver's personal judgment of the traffic situation. Check the traffic situation around the vehicle with your own eyes. Otherwise, an accident could result from road users or objects located outside of the PDC detection range.

Loud noises from outside and inside the vehicle may prevent you from hearing the PDC's signal tone. ◀

### Malfunction



The warning light lights up. PDC is malfunctioning or has failed. Have the system checked.

To ensure full functionality of the sensors, keep the sensors clean and free of ice. When using high-pressure washers, do not spray the sensors for long periods and maintain a distance of at least 12 in/30 cm.

# CLIMATE

## VEHICLE EQUIPMENT

This chapter describes all series equipment as well as country-specific and special equipment offered for this model series. Therefore, it also describes equipment that may not be found in your vehicle, for instance due to the selected

special equipment or the country version. This also applies to safety-related functions and systems.

When using the features and systems described here, adhere to local regulations.

## AIR CONDITIONER

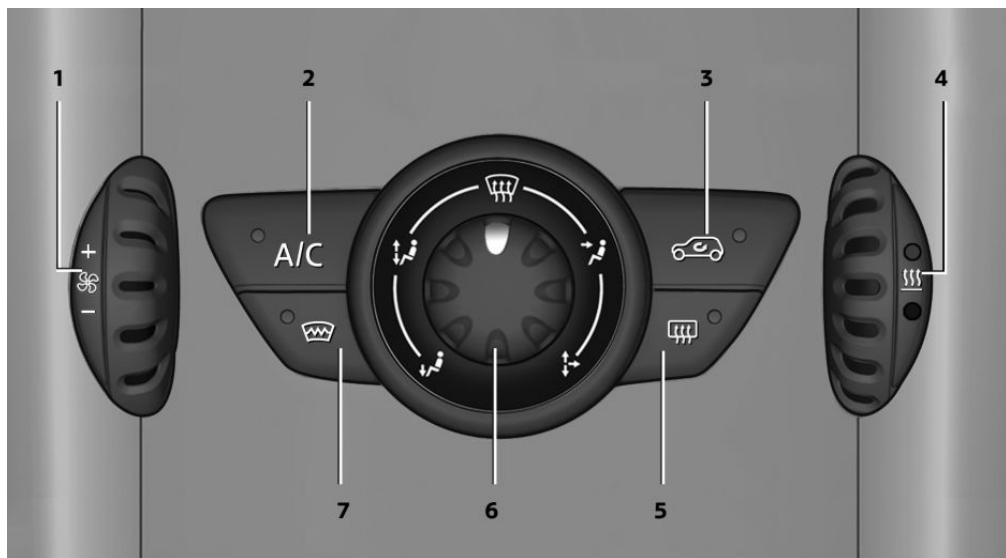

- |   |                       |   |                       |
|---|-----------------------|---|-----------------------|
| 1 | Air volume            | 5 | Rear window defroster |
| 2 | Cooling function      | 6 | Vent settings         |
| 3 | Recirculated air mode | 7 | Windshield heating    |
| 4 | Temperature           |   |                       |

### Notes



Sufficient ventilation

When remaining in the vehicle for an extended period of time, ensure sufficient external ventilation. Do not continuously use recircu-

lated-air mode; otherwise the air quality in the interior continuously worsens. ◀

## Air volume



Vary the air volume. The higher the rate, the more effective the heating or cooling will be.

The air flow rate may be reduced or the blower may be switched off entirely to save on battery power.

## Switching the system on/off

Turn the rotary switch for the air volume to 0. The blower and air conditioner are completely switched off and the air supply is cut off.

Set any air volume to switch on the air conditioning.

## Cooling function



The passenger compartment can only be cooled with the engine running.

The cooling function cools and dehumidifies the incoming air before reheating it as required, according to the temperature setting.

The cooling function helps to prevent condensation on the windows or to remove it quickly.

Depending on the weather, the windshield may fog up briefly when the engine is started.

To cool the air faster and more intensively when external temperatures are high, switch on the recirculated air mode.

## Recirculated air mode



If the air outside the car has an unpleasant odor or contains pollutants, shut off the supply to the interior of the car temporarily.

The system then recirculates the air currently within the vehicle.

Should the windows fog up in the recirculated-air mode, press the AUTO button or switch off the recirculated-air mode and increase the air

volume if necessary. Make sure that air can flow onto the windshield.

Recirculated air mode is automatically deactivated at low external temperatures.

## Temperature



Turn upward, red, to raise the temperature.

Turn downward, blue, to lower the temperature.

## Rear window defroster





The rear window defroster switches off automatically after a certain period of time.

The rear window defroster power may be lowered or even switched off entirely to save on battery power.

## Vent settings



Direct the flow of air to the windows , to the upper body area , or to the footwell . Intermediate positions are possible.

## Windshield heating



The windshield heating switches off automatically after some time.

The windshield heating may be reduced or even switched off entirely to save on battery power.

## Defrosting and defogging windows

1. Set the maximum air volume.
2. Air distribution in position .

By switching on the cooling function, the windows are defogged more rapidly.

3. Set the highest temperature, red.

4. Deactivate recirculated air mode.
5. Switch on the windshield heating if necessary.
6. Switch on the rear window defroster if necessary.

### Microfilter

The microfilter traps dust and pollen. The microfilter is changed by the service center during routine maintenance work.

### Microfilter/activated-charcoal filter

The microfilter traps dust and pollen. The activated-charcoal filter provides additional protection by filtering gaseous pollutants from the outside air. The service center replaces this combined filter during routine maintenance.

## AUTOMATIC CLIMATE CONTROL

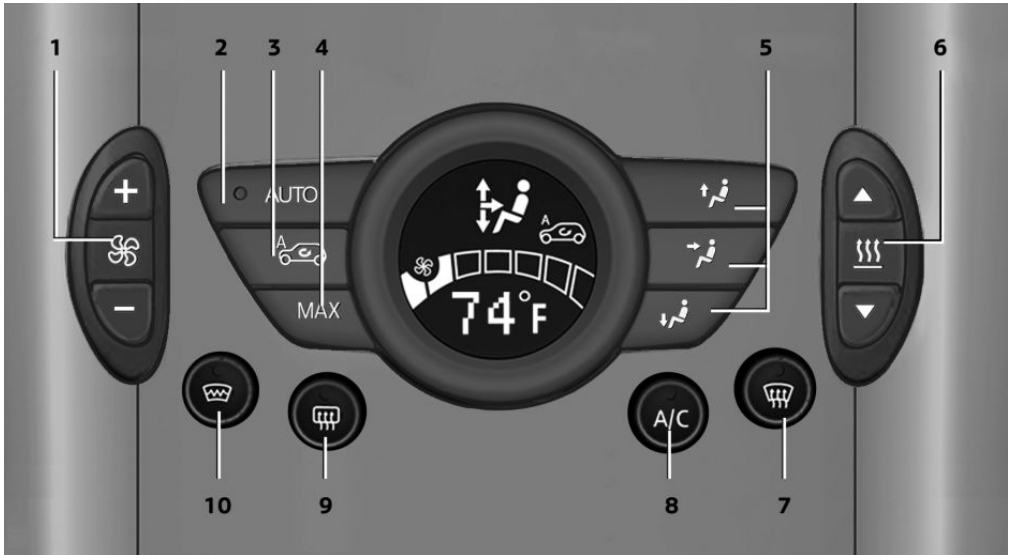

- |  |  |
|--|--|
| <ol style="list-style-type: none"> <li>1 Air volume, manual</li> <li>2 AUTO program</li> <li>3 Recirculated air mode</li> <li>4 Maximum cooling</li> <li>5 Manual air distribution</li> <li>6 Temperature</li> </ol> | <ol style="list-style-type: none"> <li>7 Defrosting windows and removing condensation</li> <li>8 Cooling function</li> <li>9 Rear window defroster</li> <li>10 Windshield heating</li> </ol> |
|--|--|

## Notes



### Sufficient ventilation

When remaining in the vehicle for an extended period of time, ensure sufficient external ventilation. Do not continuously use recirculated-air mode; otherwise the air quality in the interior continuously worsens. ◀

## Comfortable interior climate

The AUTO program offers the optimum air distribution and air volume for virtually all conditions, refer to AUTO program below. Select a comfortable interior temperature only.

The following sections contain more detailed information on the available setting options.

Most of these settings are stored for the remote control in use, Personal Profile settings, refer to page 21.

## Air volume, manual



Press the – button to reduce the air volume. Press the + button to increase the air volume.

The automatic mode for the air volume can be switched on

again using the AUTO button.

The air flow rate may be reduced or the blower may be switched off entirely to save on battery power. The display remains the same.

## Switching the system on/off

Reduce the air volume by pressing the – button until the system is switched off. All displays go out.

Press the AUTO button to switch the automatic climate control back on.

## AUTO program



The AUTO program automatically adjusts the air distribution to the windshield and side windows, toward the upper body area, and into the footwell. The air volume and your specifications for the temperature are adjusted to outside influences due to the seasons, e. g., solar radiation.

The cooling function is switched on automatically with the AUTO program.

The program is switched off if the air distribution is manually adjusted or the button is pressed again.

## Recirculated air mode



If the air outside the car has an unpleasant odor or contains pollutants, shut off the supply to the interior of the car temporarily.

The system then recirculates the air currently within the vehicle.

Should the windows fog up in the recirculated-air mode, press the AUTO button or switch off the recirculated-air mode and increase the air volume if necessary. Make sure that air can flow onto the windshield.

Recirculated air mode is automatically deactivated at low external temperatures.

## Maximum cooling



Automatic climate control switches to the lowest temperature, a high air volume, and recirculated air mode.

For maximum cooling, open the vents for the upper body area.

The air is cooled as quickly as possible:

- ▷ At an external temperature above 32 °F/0 °C.
- ▷ When the engine is running.

## Manual air distribution



The flow of air is directed, as selected, to the windows, to the upper body area, or to the footwell.

The automatic mode for the air distribution can be switched back on using the AUTO button.

## Temperature



Set the desired temperature individually.

The automatic climate control achieves this temperature as quickly as possible regardless of

the season, using maximum cooling or heating power if necessary, and then maintains it.

When switching between different temperature settings in rapid succession, the automatic climate control does not have sufficient time to adjust the set temperature.

## Rear window defroster



The rear window defroster switches off automatically after a certain period of time.

Depending on the vehicle equipment, upper wires are used as an antenna and are not part of the rear window defroster.

## Defrosting and defogging windows



Quickly removes ice and condensation from the windshield and front side windows. For this purpose, also switch on the cooling function.

The windshield heating switches on automatically.

## Windshield heating



The windshield heating switches off automatically after some time.

## Cooling function



The cooling function cools and dehumidifies the incoming air before reheating it as required, according to the temperature setting. The passenger compartment can only be cooled with the engine running.

The cooling function helps to prevent condensation on the windows or to remove it quickly.

Depending on the weather, the windshield may fog up briefly when the engine is started. Recirculated air mode is switched on automatically if necessary.

The cooling function is switched on automatically when the AUTO button is pressed.

## Microfilter/activated-charcoal filter

The microfilter traps dust and pollen. The activated-charcoal filter provides additional protection by filtering gaseous pollutants from the outside air. The service center replaces this combined filter during routine maintenance.

## VENTILATION

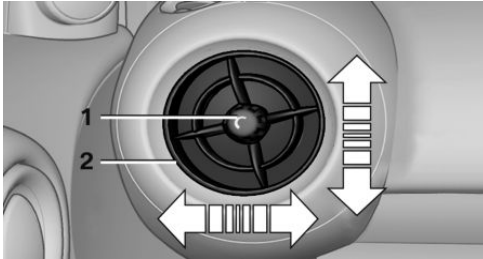

- 1 Knob for continuous opening and closing
- 2 Nozzle for direction of air flow

### Opening/closing

Turn the knob.

### Direction of air flow

Pivot the entire nozzle.

# INTERIOR EQUIPMENT

## VEHICLE EQUIPMENT

This chapter describes all series equipment as well as country-specific and special equipment offered for this model series. Therefore, it also describes equipment that may not be found in your vehicle, for instance due to the selected special equipment or the country version. This also applies to safety-related functions and systems.

When using the features and systems described here, adhere to local regulations.

## UNIVERSAL GARAGE DOOR OPENER

### The concept

The universal garage door opener can be used to operate up to 3 functions in remote-controlled systems, such as garage door drives or lighting systems. The universal garage door opener replaces up to 3 different hand-held transmitters. To operate it, the buttons on the interior rearview mirror must be programmed for the desired functions. The hand-held transmitter for the system is needed for the programming procedure.



During programming

During programming and before activating a device using the Universal Garage Door Opener, ensure that there are no people, animals, or objects in the range of movement of the remote-controlled device; otherwise, there is a risk of injury or damage.

Also follow the safety instructions of the hand-held transmitter. ◀

Before selling the vehicle, delete the stored functions for security reasons.

### Compatibility



If this symbol is printed on the packaging or in the operating instructions of the system being operated, the system is generally compatible with the universal garage door opener.

If you have any questions, please contact:

- ▷ Your service center.
- ▷ [www.homelink.com](http://www.homelink.com) on the Internet.

HomeLink is a registered trademark of the Gentex Corporation.

### Controls on the interior rearview mirror

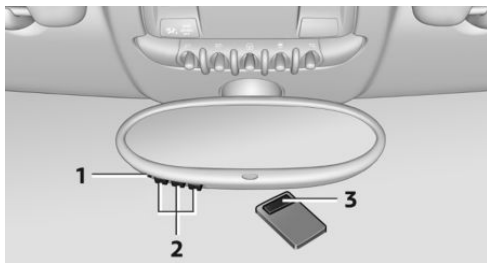

- 1 LED
- 2 Buttons
- 3 Hand-held transmitter, required for programming.

### Programming

#### General information

1. Switch on the ignition.
2. Initial setup:

Press the right and left buttons on the interior rearview mirror simultaneously for approx. 20 seconds until the LED on the interior rearview mirror begins to flash. All programmed settings of the buttons on the interior rearview mirror are deleted.



3. Hold the hand-held transmitter of the system to be operated a distance of approx. 1 to 3 in/2.5 to 8 cm away from the buttons on the interior rearview mirror. The required distance depends on the particular hand-held transmitter.
4. Press the button of the desired function on the hand-held transmitter and the button being programmed on the interior rearview mirror simultaneously and hold. The LED on the interior rearview mirror flashes slowly at first.
5. When the LED flashes more rapidly, release both buttons. Rapid flashing indicates that the button on the interior rearview mirror has been programmed.  
If the LED does not flash faster after 60 seconds, change the distance between the interior rearview mirror and the hand-held transmitter and repeat the step. Multiple trials at different distances may be necessary. Wait at least 15 seconds between trials.
6. To program additional functions on other buttons, repeat steps 3 to 5.

The systems can be operated with the buttons on the interior rearview mirror.

### Special characteristics of alternating-code radio systems

If the system cannot be operated after repeated programming, check whether the system to be operated uses an alternating-code system.

Read the operating instructions of the system or press and hold the programmed button on the interior rearview mirror. If the LED on the interior rearview mirror flashes rapidly at first and then lights up continuously for 2 seconds, the system is equipped with an alternating-code system. This flashing LED pattern repeats itself for approx. 20 seconds.

In systems with an alternating-code system, the universal garage door opener and the system must be additionally synchronized.

Please obtain additional information on synchronization in the operating instructions of the system being set up.

The systems will be easier to synchronize with the aid of a second person.

Synchronization:

1. Park the vehicle within range of the remote-controlled system.
2. Program the corresponding button on the interior rearview mirror as described.
3. Identify and press the synchronization button on the system being set up. You have approx. 30 seconds for the next step.
4. Press and hold the button on the interior rearview mirror for approx. 3 seconds and then release it. Repeat this step up to three times if necessary to complete the synchronization procedure. When synchronization is completed, the programmed function is executed.

### Reprogramming individual buttons

1. Switch on the ignition.
2. Hold the hand-held transmitter at a distance of approx. 1 to 3 in/2.5 to 8 cm from the memory buttons.  
The required distance depends on the particular hand-held transmitter.
3. Press the memory button of the universal garage door opener.
4. If the LED flashes slowly after approx. 20 seconds, press the transmit button on the hand-held transmitter.
5. Release both buttons when the LED flashes rapidly.

If the LED does not flash rapidly after approx. 60 seconds, change the distance and repeat the step.

Canada: if the LED does not flash rapidly after approx. 60 seconds, change the distance and repeat the step. If programming was aborted by the hand-held transmitter, hold down the memory button and press and release the button on the hand-held transmitter several times for 2 seconds.

## Controls



Prior to operation

Before operating a unit with the Universal Garage Door Opener, ensure that there are no people, animals, or objects in the range of movement of the system; otherwise, there is a risk of injury or damage.

Also follow the safety instructions of the hand-held transmitter. ◀

The system, such as the garage door, can be operated using the button on the interior rearview mirror with the engine running or the ignition switched on. When you are within the reception range of the system, press and hold the button until the function is initiated. The LED on the interior rearview mirror lights up continuously while the radio signal is being transmitted.

## Deleting stored functions

Press the right and left buttons on the interior rearview mirror simultaneously for approx. 20 seconds until the LED flashes rapidly. All stored functions are deleted. The functions cannot be deleted individually.

## SUN VISOR

### Glare protection

#### Folding down

Fold the sun visor down.

### Folding up

Fold the sun visor up.

### Glare protection from the side

#### Folding down

1. Fold the sun visor down.
2. Detach from the holder and pivot sideways to the side window.

### Folding up

To close the sun visor, proceed in reverse order.

### Vanity mirror

A vanity mirror is located behind a cover on each sun visor.

To open, fold the cover up.

Depending on the vehicle equipment, mirror lighting comes on when the cover is opened.

## DIGITAL COMPASS

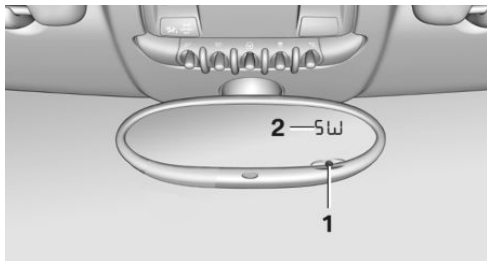

- 1 Adjustment button on the back of the mirror
- 2 Display

The display shows the main or secondary compass direction in which the vehicle is traveling.

### Operating concept

Various functions can be called up by pressing the adjustment button with a pointed object such as a pen. The following adjustment options are displayed one after the other, de-

pending on how long the adjustment button is pressed:

- ▶ Press briefly: switch the display on/off.
- ▶ 3 to 6 seconds: set the compass zone.
- ▶ 6 to 9 seconds: calibrate the compass.
- ▶ 9 to 12 seconds: set left-hand/right hand steering.

- ▶ 12 to 15 seconds: set the language.

### Setting compass zones

Set the compass zone corresponding to the vehicle's geographic location so that the compass can function correctly; refer to the world map with compass zones.

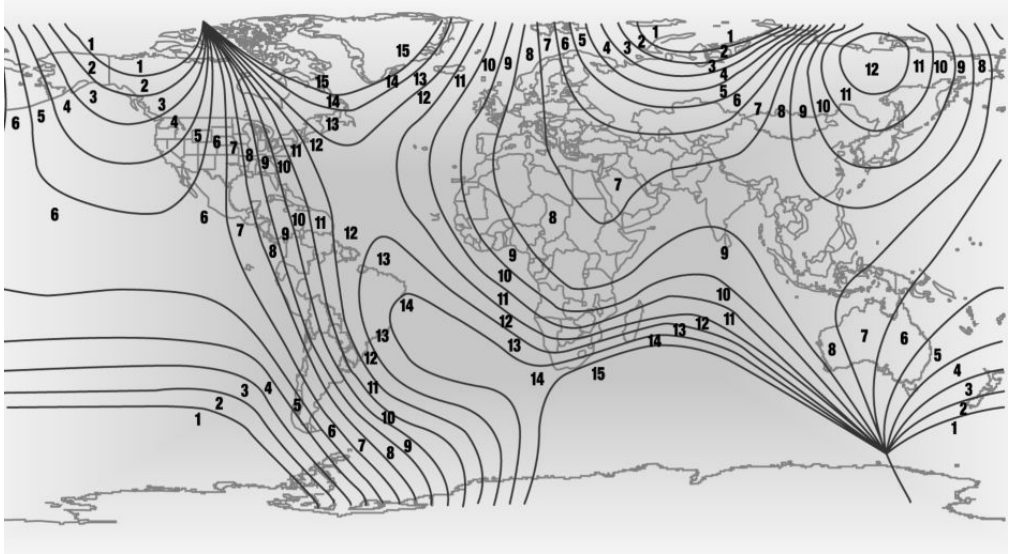

Press the adjustment button for 3-4 seconds. The number of the compass zone set is shown in the display.

To change the zone setting, briefly press the adjustment button repeatedly until the display shows the number of the compass zone corresponding to the current location.

The compass is operational again after approx. 10 seconds.

### Calibrating the digital compass

The digital compass must be calibrated in the following situations:

- ▶ An incorrect compass direction is shown.

- ▶ The cardinal direction displayed does not change even if the direction of travel changes.
- ▶ Not all compass directions are shown.

### Procedure

1. Make sure that there are no large metal objects or overhead power lines in the vicinity of the vehicle and that there is enough space to drive in a circle.
2. Set the currently valid compass zone.
3. Press the adjustment button for 6-7 seconds to call up C. Then drive at least one full circle at a maximum speed of 4 mph/7 km/h. When the system is calibrated, the C is replaced by the compass directions.

## Right-hand/left-hand steering

The digital compass is set for right-hand or left-hand steering at the factory.

## Setting the language

Press the adjustment button for 12-13 seconds. Briefly press the adjustment button again to switch between English "E" and German "O".

The setting is automatically saved after approx. 10 seconds.

## CUPHOLDERS AND ASHTRAY/LIGHTER



### Cupholders

Two cupholders are located in the center console in the front.

MINI Countryman: two additional cupholders are located at the end of the center console in the rear. Additional cupholders can be installed on the center rail.

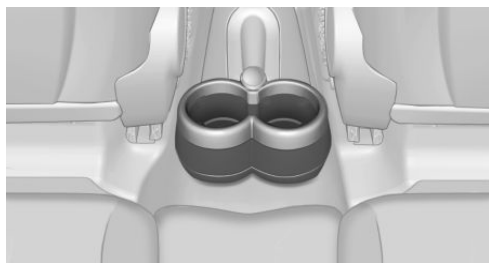

MINI Paceman: additional cupholders are located in the console between the rear seats.



Depending on the equipment, additional cupholders can be installed on the center rail.

**!** Shatter-proof containers and no hot drinks

Use light and shatter-proof containers and do not transport hot drinks. Otherwise, there is the increased danger of injury in an accident. ◀

**!** Unsuitable containers  
Do not forcefully push unsuitable containers into the cupholders. This may result in damage. ◀

### Ashtray

The ashtray is located in one of the cupholders in the center console at the front.

### Emptying

Take out the entire ashtray, arrow.

When installing, ensure that the ashtray is inserted in the cupholder with the adapter.

### Lighter

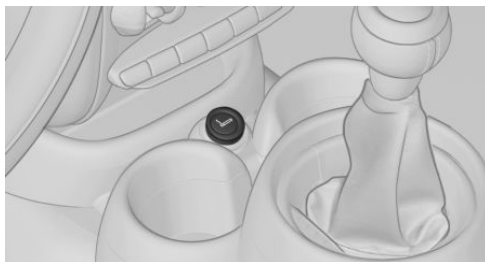

With the engine running or the ignition switched on, press in the cigarette lighter.

The lighter can be removed as soon as it pops back out.

**⚠** Danger of burns

Only hold the hot lighter by its head; otherwise, there is the danger of getting burned. Switch off the ignition and take the remote control with you when leaving the vehicle so that children cannot use the lighter and burn themselves. ◀

## CONNECTING ELECTRICAL DEVICES

The lighter socket can be used as a socket for electrical equipment while the engine is running or when the ignition is switched on. The total load of all sockets must not exceed 140 watts at 12 volt.

Avoid damaging the sockets by attempting to insert plugs of unsuitable shape or size.

**⚠** Do not connect the charger to the socket  
Do not connect the battery charger to the socket installed in the vehicle at the factory as this could damage the battery. ◀

**⚠** Replace the cover after use  
Replace the lighter or socket cover after use; otherwise, objects that fall into the lighter socket or power socket could cause a short circuit. ◀

### Socket in the center console

Remove the cover or lighter, refer to page 98, from the socket.

### Socket in the rear

#### MINI Countryman

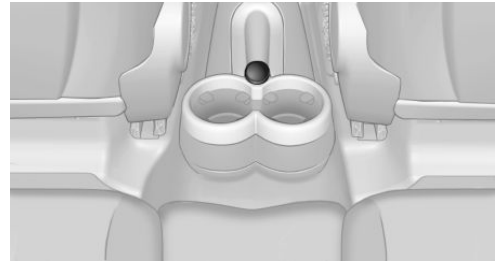

Take out the cover.

#### MINI Paceman

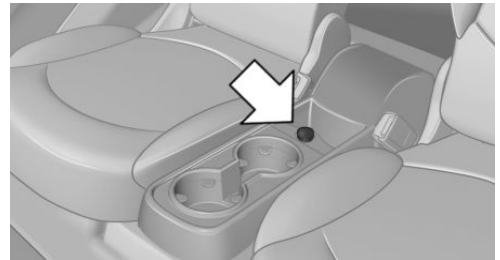

Take out the cover.

### Socket in the cargo area

#### MINI Countryman

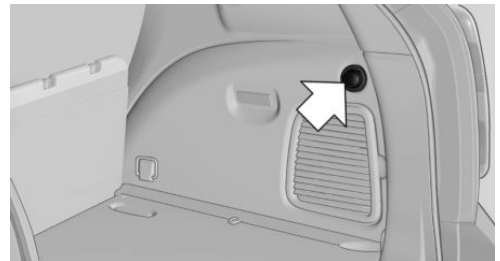

Take out the cover.

## MINI Paceman

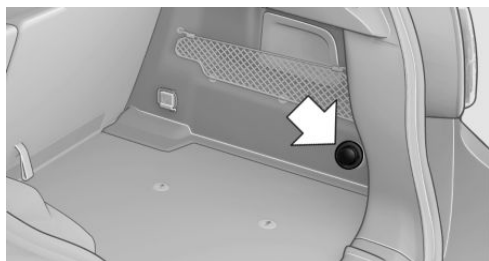

Take out the cover.

## CARGO AREA

## Cargo cover

 Do not place objects on the covers  
Do not place objects on the cover; if you do so, they may pose a danger to vehicle occupants during braking or evasive maneuvers or damage the cover. ◀

 Move the cover into position  
When closing, ensure that the cargo cover is resting on the rubber buffers of the securing straps; otherwise, damage may occur when closing the tailgate. ◀

When the tailgate is opened, the cargo cover is raised.

To load bulky luggage, the cover can be removed.

1. Detach the securing straps from the tailgate.
2. Lift the cover slightly, arrow 1, and pull it back and out of the bracket, arrow 2.

MINI Countryman:

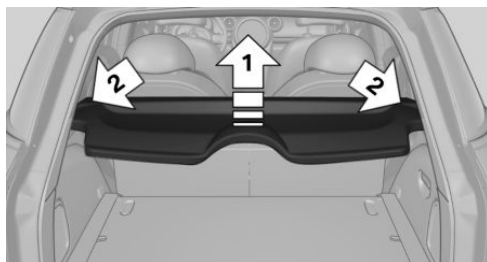

MINI Paceman:

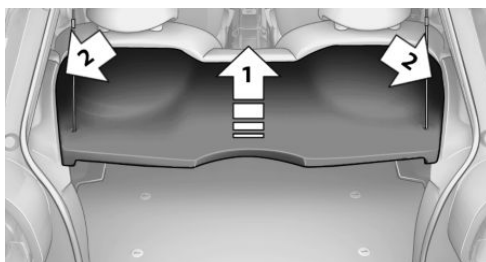

## MINI Countryman: rear seat backrests

 Danger of pinching  
Before folding down the rear seat backrests, ensure that path of movement of the backrests is clear. Especially when the middle section is folded down, ensure that no one is located in or reaches into the path of movement of the rear seat backrests. Otherwise, injuries or damage may result. ◀

 Observe the instructions concerning the safety belt

Observe the instructions concerning the safety belt, refer to page 37. Otherwise, personal protection may be compromised. ◀

The rear seat backrest is divided at a ratio of 40-20-40.

When the outer rear seat backrests are folded down, it is not permissible for a person to travel on the center seat.

Remove the third head restraint, refer to page 40, if necessary.

Open the center safety belt and insert it in the belt holder on the headliner, refer to page 38.

Enlarge the cargo area by adjusting the rear seat backrests to a more upright position.

The backrests can be adjusted to 10 different positions between the comfort and transport positions and they can be folded down.

In the comfort position, the backrests are tilted back to the greatest possible angle and in the transport position they are nearly vertical.

Before beginning with the mounting of a child restraint fixing system, note the instructions, refer to page 43.

1. Hold the top of the backrest, for example the head restraint, and pull on the loop, arrow.

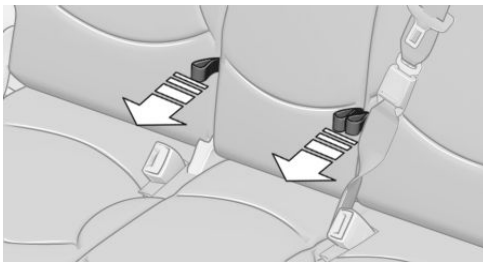

2. Engage the backrest in the desired position or fold it down.

### Folding the backrests back up

#### Locking the backrest

When folding back, ensure that the locks engage properly; otherwise, cargo could be catapulted forward into the passenger compartment during braking maneuvers and swerving, endangering the occupants. ◀

#### No child restraint fixing systems

Do not mount child restraint fixing systems in the rear when the rear seat backrests are adjusted to a more vertical position; otherwise, the protection provided by these systems may be reduced. ◀

When the backrests are folded back up, they engage in the transport position.

To set the desired backrest inclination or comfort position, hold the backrest, pull the loop forward, and adjust the backrest.

### MINI Paceman: rear seat backrests

#### Danger of pinching

Before folding down the rear seat backrests, ensure that path of movement of the backrests is clear; otherwise, injuries or damage may result. ◀

1. Fold the belt buckles down.

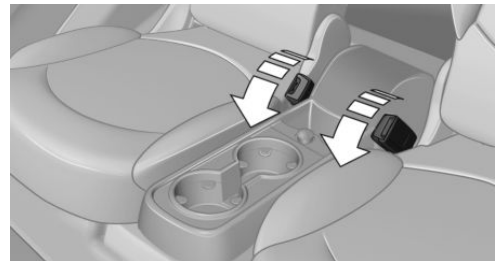

2. Pull on the respective loop, arrow. The backrest is unlocked.

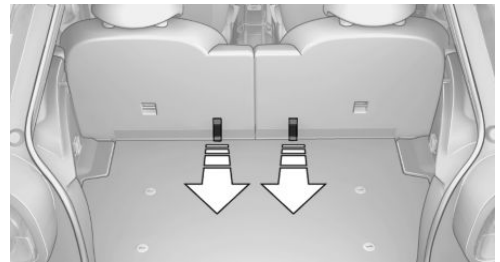

3. Fold the backrest forward.

### Folding the backrests back up

Hold the top of the backrest, for example the head restraint, and fold it back.

#### Locking the backrest

When folding back, ensure that the locks engage properly; otherwise, cargo could be catapulted forward into the passenger com-

partment during braking maneuvers and swerving, endangering the occupants. ◀

### Flat loading floor

 Maximum load

Do not exceed the maximum load of 330 lbs, 150 kg, on the loading floor; otherwise, damage may result. ◀

### Access to storage area

A storage area for items like the partition net is found under the loading floor.

1. Reach into the recess, arrow 1, on the rear edge of the loading floor.
2. Lift the loading floor at the rear, arrow 1, and fold it forward, arrow 2.

MINI Countryman:

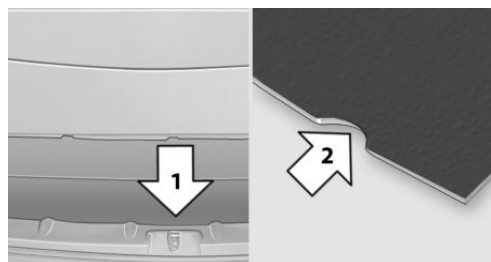

MINI Paceman:



Before closing the tailgate, lower the loading floor back onto the cargo area floor.

### Removing

The loading floor can be removed if necessary.

1. Fold up the loading floor.
2. Pull it back slightly and out of the holders.
3. Then remove it upward.

The folded loading floor can be stored in the cargo area.

### MINI Countryman: partition net

 Firmly attach the partition net

Make sure that the partition net is firmly attached; otherwise, injuries may result. ◀

### Before installing

1. Remove the pouch with the partition net from the storage compartment under the loading floor in the cargo area.
2. Take the partition net out of the pouch, unroll it, and unfold it.

After use, fold and roll up the partition net in the same manner and place it in the pouch so that it can be stowed back under the cargo floor panel. Ensure that hooks and tensioning buckles do not rest on the rod elements.

3. Unfold the partition net to the point where the rod elements engage.

### Installation behind the front seats

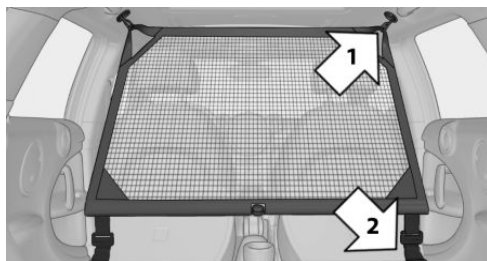

1. Take out the cargo cover if necessary.
2. Fold down the rear seat backrests, refer to Enlarging the cargo area.



3. Insert the retaining pins of the partition net all the way into the front holders in the headliner, arrow 1, and push forward.
4. Attach the hooks, arrow 2, at the bottom of the retaining straps on both sides to the eyelets on the vehicle floor.
5. Lash the partition net tightly. To do this, tighten the retaining straps using the tensioning buckles.

Only transport heavy luggage in the trunk if it has been appropriately secured. ◀

### Removing

To remove and stow the partition net, proceed in reverse order.

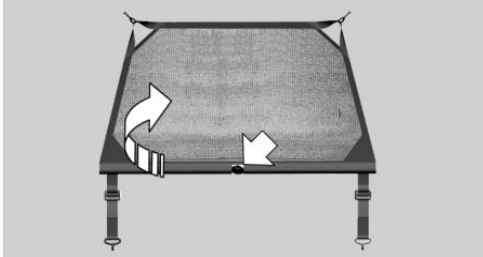

To fold up, press the release button, arrow.

### MINI Countryman: multi-function hook

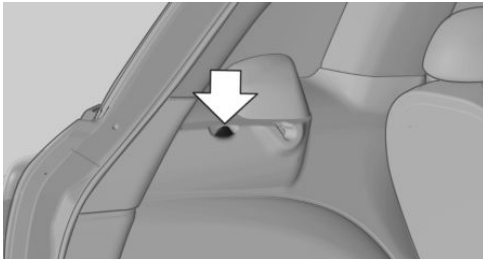

Hooks designed for hanging shopping bags and totes, for example, are located on the left and right sides of the cargo cover support, arrow.

 Do not hang heavy items from the hooks. Only hang light bags or suitable objects from the holders. Otherwise, there is a danger of objects flying about during braking and evasive maneuvers.

# STORAGE COMPARTMENTS

## VEHICLE EQUIPMENT

This chapter describes all series equipment as well as country-specific and special equipment offered for this model series. Therefore, it also describes equipment that may not be found in your vehicle, for instance due to the selected special equipment or the country version. This also applies to safety-related functions and systems.

When using the features and systems described here, adhere to local regulations.

## NOTES

 No loose objects in the passenger compartment

Do not stow any objects in the passenger compartment without securing them; otherwise, they may present a danger to occupants for instance during braking and avoidance maneuvers. ◀

 No non-slip mats on the dashboard  
Do not use non-slip materials, such as non-slip mats, on the dashboard, or it could be damaged by the substances in the materials. ◀

## STORAGE COMPARTMENTS

### Interior

- ▷ Glove compartment, refer to page 104.
- ▷ Center armrest, refer to page 105.
- ▷ Center rail, refer to page 105.
- ▷ Compartments in the center console.
- ▷ Compartments in the doors.
- ▷ Pockets on the back of the front seat backrests.

- ▷ Cupholders, refer to page 98.
- ▷ Clothes hooks, refer to page 105.

### Cargo area

- ▷ Lashing eyes, refer to page 116.
- ▷ Storage compartment under the flat loading floor, refer to page 102.
- ▷ Multi-function hook on the cargo cover support, refer to page 103.

## GLOVE COMPARTMENT

### Opening

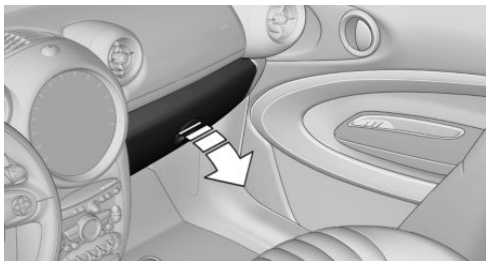

Pull the handle to open the lid.

The light in the glove compartment switches on.

### Closing

Fold up the cover.

 Close the glove compartment again immediately

Close the glove compartment immediately after use while driving; otherwise, injury may occur during accidents. ◀

## CENTER ARMREST

The center armrest between the front seats contains a storage compartment or a cover for the snap-in adapter, refer to page 143, depending on the equipment.

Do not position tall accessory parts directly on the center rail of the center armrest; otherwise, they may be damaged when the center armrest is opened or closed.

### Center armrest front

#### Opening

Press the button, arrow, and pull up the lid.

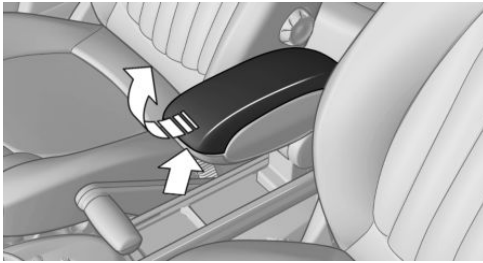

## CENTER RAIL

Various accessory parts can be mounted on the center rail and moved to different positions.

Do not use accessory parts in the area of the parking brake; otherwise, they may become damaged when the parking brake lever is activated.

### Base plate

Various accessory parts such as cupholders can be mounted on the base plate.

### Inserting the base plate

The lever 3 can be engaged in three positions.

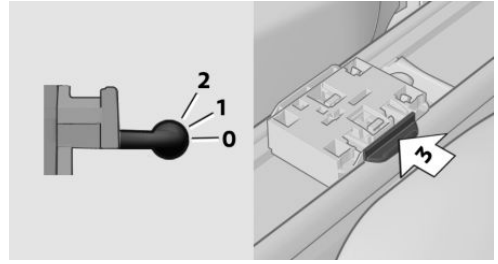

- 0 Setting
- 1 Adjusting the position on the rail
- 2 Inserting the base plate

To insert, move the lever to position 2.

### Adjusting the position and fixing

1. Push lever 3 into position 1.
2. Adjust the position of the base plate.
3. Push lever 3 downward into position 0.

Do not apply excessive pressure to the lever.

The base plate is fixed.



Fix the base plate

Fix the base plate before driving away; otherwise, injuries may result during an accident. ◀

## CLOTHES HOOKS

Clothes hooks are located on the grab handles in the rear.



Do not obstruct view

When suspending clothing from the hooks, ensure that it will not obstruct the driver's vision. ◀



No heavy objects

Do not hang heavy objects from the hooks; otherwise, they may present a danger to passengers during braking and evasive maneuvers. ◀

## CONNECTION FOR AN EXTERNAL AUDIO DEVICE

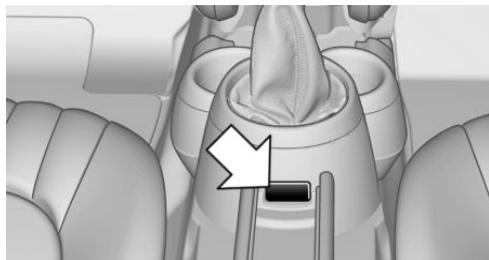

This can be used to connect an external audio device, such as a CD or MP3 player.

Radio MINI Boost CD, refer to page [130](#).





**DRIVE ME.**

**AT A GLANCE**

**CONTROLS**

**DRIVING TIPS**

**ENTERTAINMENT**

**COMMUNICATION**

**MOBILITY**

**REFERENCE**

# THINGS TO REMEMBER WHEN DRIVING

## VEHICLE EQUIPMENT

This chapter describes all series equipment as well as country-specific and special equipment offered for this model series. Therefore, it also describes equipment that may not be found in your vehicle, for instance due to the selected special equipment or the country version. This also applies to safety-related functions and systems.

When using the features and systems described here, adhere to local regulations.

## BREAKING-IN PERIOD

### General information

Moving parts need to be broken in to adjust to each other.

The following instructions will help achieve a long vehicle life and good economy.

### Engine and differential

Always obey all official speed limits.

### Up to 1,200 miles/2,000 km

Drive at various engine and vehicle speeds, but do not exceed:

- ▷ For a gasoline engine, 4,500 rpm and 100 mph/160 km/h.

Avoid full-throttle operation and use of the transmission's kickdown mode for the initial miles.

### From 1,200 miles/2,000 km

The engine and vehicle speed can gradually be increased.

### Tires

Due to technical factors associated with their manufacture, tires do not achieve their full traction potential until after an initial breaking-in period.

Drive conservatively for the first 200 miles/300 km.

### Brake system

Brakes require an initial break-in period of approx. 300 miles/500 km to achieve optimized contact and wear patterns between brake pads and discs. Drive cautiously during this break-in period.

### Clutch

The clutch requires an initial break-in period of approx. 300 miles/500 km to function at an optimal level.

During this break-in period, engage the clutch gently.

### Following part replacement

The same breaking in procedures should be observed if any of the components mentioned above have to be renewed in the course of the vehicle's operating life.

## GENERAL DRIVING NOTES

### Ground clearance



Ensure adequate ground clearance

Ensure adequate ground clearance, e.g., when driving into underground garages, when driving over curbs, or when driving in winter; otherwise, damage may occur to the vehicle. ◀



## Closing the tailgate



Drive with the tailgate closed

Only drive with the tailgate closed; otherwise, passengers and other road users may be endangered or the vehicle may be damaged if an accident occurs or during braking or swerving. In addition, exhaust fumes may enter the passenger compartment. ◀

If, despite this, the vehicle must be driven with the tailgate open:

- ▷ Drive moderately.
- ▷ Close all windows and the glass sunroof.
- ▷ Switch off recirculated air mode and greatly increase the blower speed.

## Hot exhaust system



Hot exhaust system

High temperatures are generated in the exhaust system.

Do not remove the heat shields installed and never apply undercoating to them. Make sure that flammable materials, e. g. hay, leaves, grass, etc. do not come in contact with the hot exhaust system during driving, while in idle position mode, or when parked. Such contact could lead to a fire, and with it the risk of serious personal injury as well as property damage.

Do not touch hot exhaust pipes; otherwise, there is the danger of getting burned. ◀

## Mobile communication devices in the vehicle



Mobile communication devices in the vehicle

It is not recommended to use mobile phones, such as mobile phones without a direct connection to an external aerial in the vehicle's passenger compartment. Otherwise, the vehicle electronics and mobile communication devices can interfere with each other. In addition, there is no assurance that the radiation gener-

ated during transmission will be discharged from the vehicle interior. ◀

## Hydroplaning

On wet or slushy roads, a wedge of water can form between the tires and road surface.

This phenomenon is referred to as hydroplaning. It is characterized by a partial or complete loss of contact between the tires and the road surface, ultimately undermining your ability to steer and brake the vehicle.



Hydroplaning

When driving on wet or slushy roads, reduce your speed to prevent hydroplaning. ◀

The risk of hydroplaning increases as the tire tread depth decreases. Minimum tread depth, refer to page 158.

## Driving through water

Drive through calm water only if it is not deeper than 12 inches/30 cm and at this height, no faster than walking speed, up to 6 mph/10 km/h.

## Using the parking brake on inclines



Using the parking brake

On inclines, do not hold the vehicle stationary with a slipping clutch for extended period; use the parking brake instead. Otherwise, the clutch will be subject to increased wear. ◀

Support from the hill drive-off assistant, refer to page 83.

## Braking safely

The vehicle is equipped with ABS as a standard feature.

Applying the brakes fully is the most effective way of braking in situations when this is necessary.

The vehicle maintains steering responsiveness. You can still avoid any obstacles with a minimum of steering effort.

Pulsation of the brake pedal and sounds from the hydraulic circuits indicate that ABS is in its active mode.

 Do not let your foot rest on the brake pedal

Do not drive with your foot resting on the brake pedal. Even light but consistent pedal pressure can lead to high temperatures, brake wear and possibly even brake failure. ◀

### Objects in the area around the pedals

 No objects in the area around the pedals  
Keep floor mats, carpets, and any other objects out of the area of motion of the pedals; otherwise, the function of the pedals could be impeded while driving

Do not place additional floor mats over existing mats or other objects.

Only use floor mats that have been approved for the vehicle and can be properly fixed in place.

Ensure that the floor mats are securely fastened again when they are returned after being removed, such as for cleaning. ◀

### Driving in wet conditions

When roads are wet or there is heavy rain, briefly exert gentle pressure on the brake pedal every few miles.

Ensure that this action does not endanger other road users.

The heat generated in this process helps dry the brake discs and pads.

In this way braking efficiency will be available when you need it.

### Hills

Drive long or steep downhill gradients in the gear in which the least braking is required. Otherwise, the brake system may overheat, resulting in a reduction in the brake system efficiency.

You can increase the engine's braking effect by shifting down, going all the way to first gear, if necessary.

Downshifting in manual mode of the Steptronic transmission, refer to page 56.

 Avoid load on the brakes  
Avoid placing excessive load on the brake system. Light but consistent brake pressure can lead to high temperatures, brake wear and possibly even brake failure. ◀

 Do not drive in neutral  
Never drive with the transmission in neutral, with the engine switched off or with the clutch depressed; otherwise, you will have neither the braking action of the engine or nor its power assistance when braking or steering. ◀

### Brake disc corrosion

Corrosion on the brake discs and contamination on the brake pads are furthered by:

- ▷ Low mileage.
- ▷ Extended periods when the vehicle is not used at all.
- ▷ Infrequent use of the brakes.

Corrosion occurs when the minimum pressure that must be exerted by the pads during brake applications to clean the discs is not reached.

Should corrosion form on the brake discs, the brakes will tend to respond with a pulsating effect that generally cannot be corrected.

### When the vehicle is parked

When using the automatic climate control, condensation water develops that exits underneath the vehicle.

Therefore, traces of condensed water under the vehicle are normal.

After the engine is switched off, the coolant pump may continue running for some time in the MINI Cooper S. This causes noises in the engine compartment.

## Driving on poor roads

Your MINI with ALL4 all-wheel drive feels comfortable on all streets and roads. It combines an all-wheel drive system with the advantages of a normal passenger car.



Do not drive on unpaved terrain

Do not drive on unpaved terrain, as otherwise the vehicle may be damaged. ◀

For your own safety and the safety of passengers and the vehicle, adhere to the following points:

- ▶ Familiarize yourself with the vehicle before driving; never take risks.
- ▶ Adjust speeds according to road conditions. The steeper and rougher the road surface is, the lower the speed should be.
- ▶ When driving on steep uphill and downhill grades: the engine oil and coolant should be filled nearly to the MAX mark.
- ▶ Watch for stones, holes, and other obstacles and drive around these where possible.
- ▶ On bumps and rough roads, avoid contact between the vehicle body and the ground. The maximum ground clearance is 6 inches/15 cm and may vary with the loaded cargo.
- ▶ When driving through water, do not exceed the maximum water height of 12 inches/30 cm and drive at walking speed.
- ▶ After driving through water, press on the brake pedal several times at low speeds to dry the brakes.
- ▶ Depending on the prevailing terrain, activate Dynamic Traction Control DTC briefly, refer to page 82.
- ▶ When the wheels spin, accelerate to enable the driving stability control systems to distribute the drive force to the individual wheels.

## After driving on poor roads

Adhere to the following points to ensure vehicle safety:

- ▶ Remove excessive accumulations of dirt and mud from the vehicle body.
- ▶ Clear mud, snow, ice, etc., from the wheels and tires and check for damage.

# LOADING

## VEHICLE EQUIPMENT

This chapter describes all series equipment as well as country-specific and special equipment offered for this model series. Therefore, it also describes equipment that may not be found in your vehicle, for instance due to the selected special equipment or the country version. This also applies to safety-related functions and systems.

When using the features and systems described here, adhere to local regulations.

## GENERAL INFORMATION

### Overloading the vehicle

To avoid exceeding the approved carrying capacity of the tires, never overload the vehicle. Overloading can lead to overheating and increases the rate at which damage develops inside the tires. This could result in a sudden loss of tire inflation pressure. ◀

### No fluids in the cargo area

Make sure that fluids do not leak into the cargo area; otherwise, the vehicle may be damaged. ◀

## DETERMINING THE LOAD LIMIT

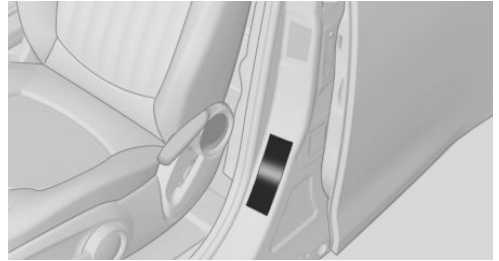

1. Locate the following statement on your vehicle's placard:
  - ▷ The combined weight of occupants and cargo should never exceed XXX kg or YYY lbs. Otherwise, damage to the vehicle and unstable driving situations may result.
2. Determine the combined weight of the driver and passengers that will be riding in your vehicle.
3. Subtract the combined weight of the driver and passengers from XXX kilograms or YYY pounds.
4. The resulting figure equals the available amount of cargo and luggage load capacity.
 

For example, if the YYY amount equals 1,000 lbs and there will be four 150 lbs passengers in your vehicle, the amount of available cargo and luggage load capacity is 400 lbs: 1,000 lbs minus 600 lbs = 400 lbs.
5. Determine the combined weight of luggage and cargo being loaded on the vehicle. That weight may not safely exceed the

available cargo and luggage load capacity calculated in Step 4.

- If your vehicle will be towing a trailer, load from your trailer will be transferred to your vehicle. Consult the manual for transporting a trailer to determine how this may reduce the available cargo and luggage load capacity of your vehicle.

## LOAD

4-seater:

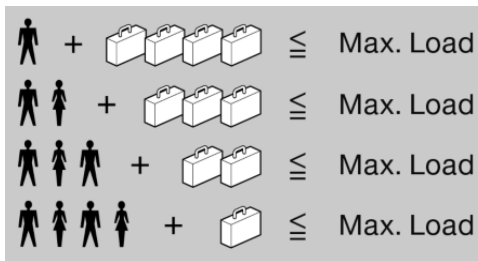

5-seater:

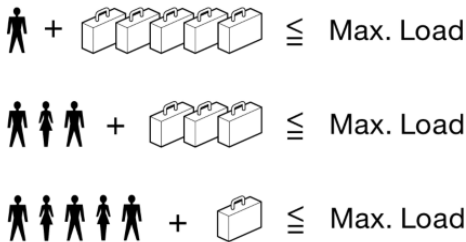

The maximum load is the sum of the weight of the occupants and the cargo.

The greater the weight of the occupants, the less cargo that can be transported.

## STOWING CARGO

- Very heavy cargo: when the rear seat is not occupied, secure each of the outer safety belts in the opposite buckle.

- Heavy cargo: stow as far forward and as low as possible, ideally directly behind the backrests.
- Cover sharp edges and corners.
- Do not pile cargo higher than the top edge of the backrests.
- If necessary, fold down the rear backrests to stow cargo.
- Use the partition net, refer to page 102, to protect passengers. Make sure that objects cannot penetrate the partition net.
- Place protective material around any sharp-edged or pointed objects that could bump against the rear window while the vehicle is in motion.

### MINI Countryman

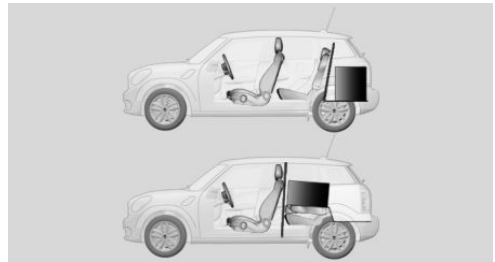

### MINI Paceman

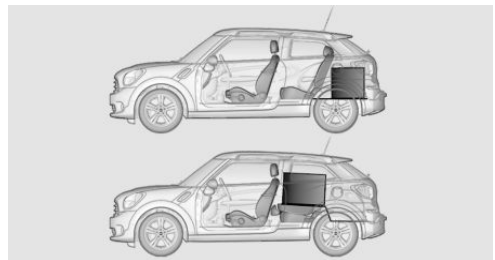

## SECURING CARGO

### Lashing eyes in the cargo area

#### MINI Countryman

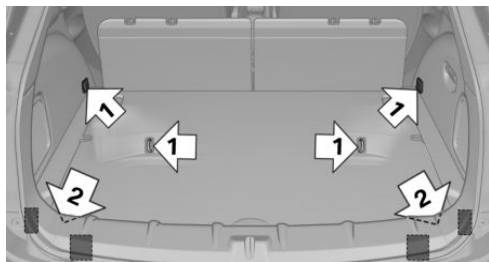

#### MINI Paceman

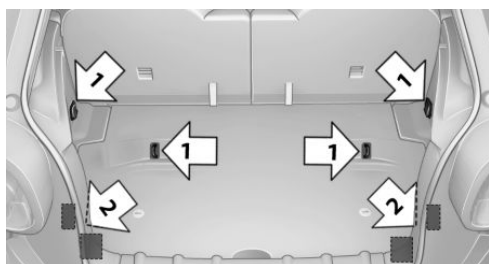

### Securing cargo

- ▷ Secure smaller and lighter pieces with tightening belts or straps.
- ▷ Secure larger and heavier pieces with cargo straps.

Adhere to the information included with the cargo straps.

- ▷ Eight mounting eyes are available for fastening the cargo straps.

Two of them are located on the side wall of the cargo area, arrows 1, and two are located on the rear wall of the cargo area, arrows 2.

### Securing cargo

Stow and secure the cargo as described above; otherwise it may present a danger to the occupants, for instance during braking and avoidance maneuvers.

Do not stow any heavy and hard objects in the passenger compartment without securing them; otherwise, they may present a danger to occupants, for instance during braking and avoidance maneuvers.

Never exceed either the approved gross vehicle weight or either of the approved axle loads, as excessive loads can pose a safety hazard, and may also place you in violation of traffic safety laws.

Do not secure cargo using the upper LATCH mounting points, refer to page 45; otherwise, these may become damaged. ◀

## ROOF-MOUNTED LUGGAGE RACK

### Notes

A special rack system is available as an optional accessory.

### Attachment

Follow the installation instructions for the roof-mounted luggage rack.

Ensure that adequate clearance is available for the movement of the glass sunroof.

### Loading

Because roof racks raise the vehicle's center of gravity when loaded, they have a major effect on vehicle handling and steering response.

Therefore, note the following when loading and driving:

- ▷ Do not exceed the approved roof/axle loads and the approved gross vehicle weight.

- ▷ Distribute the roof load uniformly.
- ▷ The roof load should not be too large in area.
- ▷ Always load the heaviest pieces on the bottom.
- ▷ Fasten the roof-mounted luggage securely, for instance using lashing straps.
- ▷ Do not let objects project into the opening path of the tailgate.
- ▷ Drive smoothly. Avoid sudden acceleration and braking maneuvers. Take corners gently.

## REAR LUGGAGE RACK

### Notes

A special rear rack is available as an optional accessory. It does not require a trailer hitch. Follow the installation instructions for the rear rack.

### Anchorage points

MINI Countryman:



MINI Paceman:

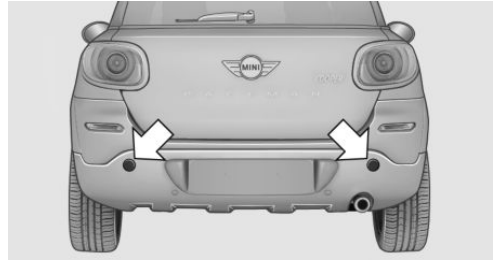

The anchorage points are under the covers in the bumper.

Push out the covers on the corresponding cut-outs.

### Loading

When loading the vehicle, ensure that the approved gross vehicle weight and the axle loads are not exceeded. Adhere to the weight specifications in the technical data.

# SAVING FUEL

## VEHICLE EQUIPMENT

This chapter describes all series equipment as well as country-specific and special equipment offered for this model series. Therefore, it also describes equipment that may not be found in your vehicle, for instance due to the selected special equipment or the country version. This also applies to safety-related functions and systems.

When using the features and systems described here, adhere to local regulations.

## GENERAL INFORMATION

Your vehicle contains advanced technology for the reduction of fuel consumption and emissions.

Fuel consumption depends on a number of different factors. The implementation of certain measures, driving style and regular maintenance can have an influence on fuel consumption and on the environmental impact.

### Remove unnecessary cargo

Additional weight increases fuel consumption.

### Remove attached parts following use

Remove unneeded auxiliary mirrors, roof or rear luggage racks after use.

Attached parts on the vehicle impair the aerodynamics and increase the fuel consumption.

### Close both windows

Open windows causes higher air resistance and thus increases fuel consumption.

### Check the tire inflation pressure regularly

Check and, if necessary, correct the tire inflation pressure, refer to page 152, at least twice a month and before starting on a long trip.

Low tire inflation pressure increases rolling resistance and thus raises fuel consumption and tire wear.

### Drive away without delay

Do not wait for the engine to warm-up while the vehicle remains stationary. Start driving right away, but at moderate engine speeds. This is the fastest way for the cold engine to reach its operating temperature.

### Look well ahead when driving

Avoid unnecessary acceleration and braking. To achieve this, maintain a suitable distance to the vehicle driving ahead of you.

Driving smoothly and looking ahead reduces fuel consumption.

### Avoid high engine speeds

Use 1st gear to get the vehicle in motion. Beginning with 2nd gear, accelerate rapidly. When accelerating, shift up before reaching high engine speeds.

When you reach the desired speed, shift into the highest applicable gear and drive with the engine speed as low as possible and at a constant speed.

As a rule: driving at low engine speeds lowers fuel consumption and reduces wear.

### Use coasting conditions

When approaching a red light, take your foot off the accelerator and coast to a halt in the highest applicable gear.



On a downhill slope, take your foot off the accelerator and coast in a suitable gear.

The flow of fuel is interrupted while coasting.

### **Switch off the engine during longer stops**

Switch off the engine during longer stops, e.g., at traffic lights, railroad crossings or in traffic congestion.

Fuel savings are already achieved after the engine is turned off for as little as 4 seconds.

### **Switch off any functions that are not currently needed**

Functions such as seat heating and the rear window defroster require a lot of energy and consume additional fuel, especially in city and stop-and-go traffic.

Therefore, switch off these functions if they are not actually needed.

### **Have maintenance carried out**

Have vehicles maintained regularly to achieve optimal vehicle economy and operating life. Have the maintenance carried out by the service center.

Please also note the MINI maintenance system, refer to page [169](#).



**ROCK ME.**

**AT A GLANCE**

**CONTROLS**

**DRIVING TIPS**

**ENTERTAINMENT**

**COMMUNICATION**

**MOBILITY**

**REFERENCE**

# RADIO MINI BOOST CD

## VEHICLE EQUIPMENT

This chapter describes all series equipment as well as country-specific and special equipment offered for this model series. Therefore, it also describes equipment that may not be found in your vehicle, for instance due to the selected

special equipment or the country version. This also applies to safety-related functions and systems.

When using the features and systems described here, adhere to local regulations.

## GENERAL INFORMATION

### At a glance

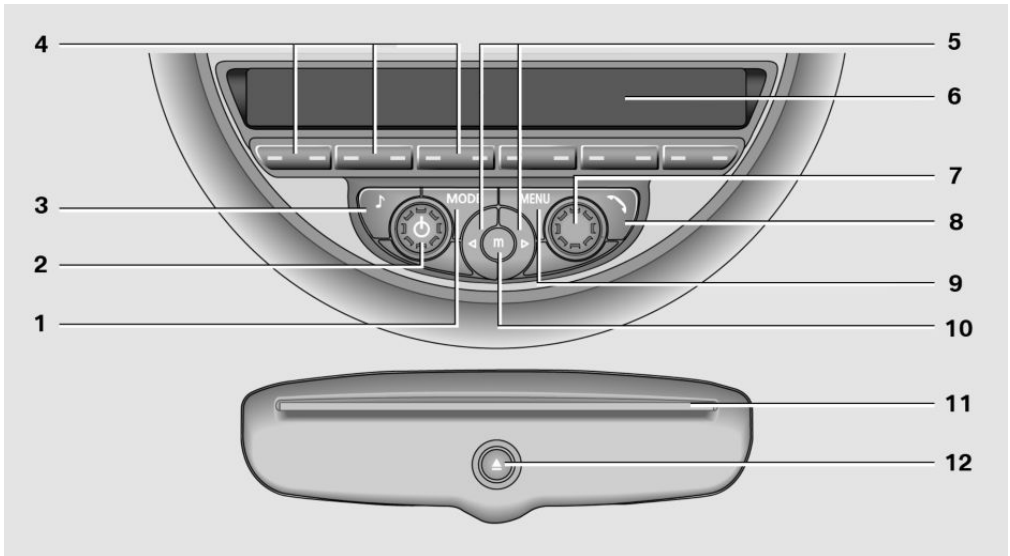

- |  |   |
|--|---|
| <p><b>1</b> Change the audio sources.</p> <p><b>2</b> On/off, volume.</p> <ul style="list-style-type: none"> <li>▷ Press: switch on/off.</li> <li>▷ Turn: adjust the volume.</li> </ul> <p><b>3</b> Show the tone settings.</p> <p><b>4</b> Function buttons for selecting the menu items shown directly above them on the display.</p> <p><b>5</b> Change the station or track.</p> | <p><b>6</b> Display.</p> <p><b>7</b> Select the functions.</p> <ul style="list-style-type: none"> <li>▷ Turn: highlight the menu item on the display or set the value.</li> <li>▷ Press: select the highlighted menu item or store the settings.</li> </ul> <p><b>8</b> Place/end calls.</p> <p><b>9</b> Opens the main menu.</p> <p><b>10</b> Manually select the frequency.</p> |
|--|---|

11 CD slot.

## Representation in the Owner's Manual



"..." Identifies radio display texts used to select individual functions.

## Menu navigation

Radio and telephone functions can be opened using buttons on the radio and menus.

## Opening menu items

To display the menu items:

- ▶  Press the button once for the audio sources menu.
- ▶  Press the button for the main menu.

## Selecting menu items

There are several ways to select a menu item on the display.

## Using the right knob

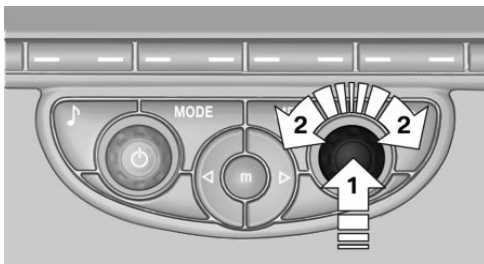

- ▶ To mark a menu item: turn the right knob, arrow 2.
- ▶ To select a menu item: press the right knob, arrow 1.

## Using the function buttons

 Press the left or right side of the function button under the menu item.

12 Eject the CD.

If only one menu item is displayed above the function button, press the middle of the button.

## Via the MODE button

 Press the button repeatedly until the desired audio menu is selected.

## Symbols on the display

Symbol	Meaning
✓	Function is selected.
☑	Function is activated.
☐	The function is deactivated.
←	Leave the menu, one menu back.
◀ ▶	Display additional menu items.
◆	Scroll display. The list contains more than two entries.
↑	Change to the higher level directory.

## Setting values

For setting numerical values or values on a scale:

1. Mark the desired menu item and press the right knob.
2. Turn the right knob to set the value.
3. Press the right knob to store the value.

## Switching on/off

Press the left knob. The radio selects the audio source set last: radio, satellite radio, CD, external audio device, or USB audio interface.

## Listening to the radio with the ignition switched off

When the radio ready state or the ignition is switched off, the radio functions are available

for approx. 20 minutes. To listen to the radio, switch it back on.

To spare the battery, ensure that the radio is switched off when you leave the vehicle.

### Adjusting the volume



Turn the left knob. The setting is stored for the remote control currently in use.

When a call is placed using the hands-free system, the audio sources are muted.

### Speed-dependent volume and volumes of PDC signal tone and gong

- ▷ "PDC": volume of the PDC signal tone compared to the audio sources.
- ▷ "GONG": volume of the gong compared to the audio sources.
- ▷ "S-VOL": speed-dependent volume control.

Set the audio sources to a high volume to be able to adjust the volume of the signal tones more easily.

1.  Press the button.
2.  Select the symbol if necessary.
3. Select the desired volume setting.
4. Set the desired volume and press the right knob.

### Volume of external audio devices

An external audio device such as an MP3 player can be connected via the AUX-IN port in the center console and the audio tracks can be played over the car's loudspeaker system.

The volume of the external audio device can be adjusted to the car radio.

1.  Press the button.
2. "AUX"
3. "Vol-AUX"
4. Set the desired volume and press the right knob.

### Tone settings

- ▷ "BASS": depth adjustment.
- ▷ "TREBLE": treble adjustment.
- ▷ "FADER": front/rear volume distribution.
- ▷ "BAL": left/right volume distribution.

The sound settings are set globally for all audio sources.

### Setting the treble, bass, and volume distribution

1.  Press the button.
2. Highlight the desired tone setting and press the right knob.
3. Create the desired setting and press the right knob.

### Resetting the tone settings

The tone settings are reset to medium values.

1.  Press the button.
2. "RESET"

### Time

#### Setting the time, date, and time format

1. Switch on the radio ready state or the ignition.
2.  Press the button.
3. "CONFIG"
4. "TIME"
5. Select the desired category.
6. Create the settings and press the right knob.

## Setting the units of measure of the computer and the language

1. Switch on the radio ready state or the ignition.
2.  Press the button.
3. "CONFIG"
4.
  - ▷ "DIST": change the unit of measure for the range.
  - ▷ "LANG": select the language of the display texts.
  - ▷ "CONSPM": change the unit of measure for the average fuel consumption.
  - ▷ "TEMP": change the unit of measure for the external temperature.
5. Highlight the desired menu item and press the button.
6. Create the desired setting.

## Computer

The following vehicle information can be call up via the computer:

- ▷ Average fuel consumption
- ▷ Average speed
- ▷ Range

## Displaying information

1. Switch on the radio ready state or the ignition.
2.  Press the button.
3. "COMP"

## Average fuel consumption

The average fuel consumption is calculated for the time during which the engine is running.

To start calculation of the average fuel consumption:

1. "CONSPM"
2. "RESET"

The previous display is set to zero and the system begins recalculating the average fuel consumption.

## Average speed

The average speed is calculated for the time during which the engine is running.

To start calculation of the average speed:

1. "SPEED"
2. "RESET"

## Estimated range

"RANGE"

The display shows the estimated distance that can be still be driven on the remaining fuel, taking into consideration the driving style over the last 18 miles/30 km.

## RADIO

### Listening to the radio

The radio is designed for reception in the FM and AM wavebands.

1. Switch on the radio, refer to page [123](#).
2.  Press this button if necessary.
3. "TUNER"
4. "FM" or "AM"

Press the corresponding button repeatedly until the desired waveband is displayed.

- ▷ FM: FM1, FM2, FMA
- ▷ AM: AM, AMA

### Selecting a station

The setting is stored for the remote control currently in use.

### Next station



Press the button.

The next station with reception is selected.

### Selecting the station manually by frequency

1.  Press the button.
2. ▷ Press the respective function button to set the desired frequency.
  - ▷ Turn the right knob until the desired frequency is set.

### Automatically updating the stations with the best reception, AUTOSTORE

In the FMA and AMA memory levels, stations are automatically stored according to their reception strength. If the AUTOSTORE function is not used, six stations can be manually stored in each of the FMA and AMA memory levels.

1. "FM" or "AM"  
Press the corresponding button until the following is displayed:  
"AUTOSTORE"

It may take several seconds for the stations to be stored and for one of these stations to be played back.

### Briefly playing and selecting a station

"SC"

All stations with reception are played briefly.

To interrupt the function and select a station:

"SC"

### Storing and retrieving a station

#### Memory locations

It is possible to store up to 30 stations.

- ▷ FM1, FM2, AM: six stations each.
- ▷ FMA, AMA: the six stations with the best reception (automatically) or any six stations (manually).

### Storing a station

1. "FM" or "AM"  
Select the desired function repeatedly until the desired waveband is displayed.
2. Select the station.
3. "1" ... "6"  
Press and hold the function button under the desired memory location until the station is audible again after a brief interruption.

### Retrieving a stored station

1. "FM" or "AM"  
Select the desired function repeatedly until the desired waveband is displayed.
2. "1" ... "6"  
Press and hold the desired function button or turn the right knob until the desired station is displayed.

### Radio Data System, RDS

RDS broadcasts additional information, such as the station name or text messages, in the FM waveband. When playing a station with multiple frequencies, the system automatically switches to the frequency with the best reception, if needed.

Some stations broadcast the type of program received, or PTY, via RDS. This information is displayed briefly when the station is selected, for instance NEWS.

PTY can also be used to display catastrophe alerts, such as "ALARM".

The alert is issued on the loudspeakers.

### Switching the RDS on/off

1. "SET"
2. "RDS"

When the RDS is switched off, the PTY function is switched off as well.



## Switching the program type display on/off

1. "SET"
2. "PTY"

## HD Radio™ reception

Many stations broadcast both analog and digital signals. These stations can be received digitally and therefore with better sound quality. A digital radio network must be available to be able to receive digital stations.

License conditions

HD Radio Technology manufactured under license from iBiquity Digital Corporation. U.S. and Foreign Patents. HD Radio™ and the HD, HD Radio, and Arc logos are proprietary trademarks of iBiquity Digital Corp.

## Activating/deactivating digital radio reception

1.  Press the button.
2. "TUNER"
3. "SET"
4. "HD"



## Displays

- ▷ "HD": a station is received digitally.
- ▷ "(HD)": a station broadcasts digital signals but digital radio reception is switched off.

In areas in which the selected station is not continuously received in digital mode, playback switches between analog and digital reception. In this case, switch off digital radio reception.

## Selecting the programs of a digital station

Some stations broadcast multiple programs. To select one of these programs:

1.   Press the button repeatedly until the desired digital station is displayed. If a station broadcasts multiple programs,

the following display appears, for example: "HD1"

2. "LIST"
3. "HD1" ... "HD8" Select the desired program. Up to eight programs can be selected per station.

## Displaying additional information

For digital stations, additional information can be displayed on the current track, such as the name of the artist.

"INFO"

## Operational displays

- ▷ "acquiring": the system is looking for digital stations.
- ▷ "No Signal": no digital stations are being received.

## Satellite radio

Over 100 different channels with high fidelity can be received. The channels are offered in fixed packages and must be activated.

You may experience signal drops and muting events related to this new technology.

## Activating or deactivated channels

1.  Press the button.
2. "SAT"
3. "CAT"
4. Select the desired category. The channels are displayed.
  - ✓ This symbol identifies the current channel.

## Activating

1. Turn the right knob to select a channel that is not yet activated.
2. Press the right knob to confirm a channel.

A phone number and the electronic serial number, ESN, are displayed. The electronic serial number is required for activation.

3. To have the channels activated, call the phone number.

### Deactivating

1.  Press the button.

2. "SAT"

3. "SAT"

Hold the button down.

A phone number and the electronic serial number, ESN, are displayed. The electronic serial number is required for deactivation.

4. To have the channels deactivated, call the phone number.

### Selecting and storing a channel

1.  Press the button.

2. "SAT"

3. "CAT"

4. Select the desired category.

5. Select the desired channel.

To display all channels:

"ALL"

To store a channel:

1.  Select the symbol.

2. "SAT"

Press the button repeatedly until the desired memory level, SAT 1 or SAT 2, is reached.

3. "1" ... "6"

Press and hold the function button under the desired memory location until the channel is audible again after a brief interruption.

### Changing the current channel

"CURR"

### Additional information

The name of the channel and additional information on the current track are displayed, such as the name of the artist.



1. Select the desired channel.
2. "INFO"

### Changing the channel using the buttons



Press the button for the corresponding direction. The next enabled channel is opened.

### Search

1.   Press and hold the button for the corresponding direction. The activated channels appear on the display one after the other.
2. Release the button to select the displayed channel.

### Notes

When there is a signal blockage or the transmission is suspended momentarily for more than 4 seconds, a message will appear on the display.

Service may be interrupted or unavailable for specific reasons such as environmental or topographic conditions and others that Satellite Radio cannot directly control. Signal may not be available under tunnels, in parking garages, next to tall buildings, nearby trees with dense foliage, nearby mountains or other possible strong sources of radio interference. Service should resume normally after the source of signal unavailability has been cleared.

## CD PLAYER

### Loading the CD player

Insert the CD into the CD drive with the printed side up.

Playback begins automatically.

Reading can take a few minutes with compressed audio files.

### Starting the CD player

A CD is contained in the CD player.

1. Switch on the car radio if necessary.
2.  Press the button.
3. "CD"

### Skipping to another track



Press the button repeatedly until the desired track is played.

With the right knob:

Turn the right knob until the desired track is played back.

### Fast forward/reverse



Hold the button down.

Tracks can be heard but are distorted.

### Briefly playing and selecting a track

"SC"

All tracks are played briefly one after the other.

To interrupt the function and select a track:

"SC"

### Random playback

"RND"



To end random playback:

"RND"

### Compressed audio files

CD players can play back CDs with compressed audio data: MP3 and WMA.

### Selecting a track

1. "LIST"
2. Select the desired directory using the right knob.
  - ▷  : press the right knob to open a directory.
  - ▷  : press the right knob to close a directory.
3. Select other directories if you wish.
4. Highlight the desired track and press the right knob.

You can scroll through the directories during playback.

To change to the current track:

"CURR"

### Displaying information on the track

Any information stored on the currently selected track can be displayed.

1. "LIST"
2. "TRACK"

### Ejecting a CD from the CD player



Press the button.

The CD emerges slightly from the CD drive.

### Operational displays

- ▷ "Insert CD"  
The CD slot is empty.
- ▷ "Error CD"  
The CD cannot be read or is defective.
- ▷ "Temp. CD"  
Operating temperature is too high.

## Notes

### CD player



Do not remove the cover

The CD players are officially designated Class 1 laser products. Do not operate if the cover is damaged; otherwise, severe eye damage can result. ◀

### CDs



Using CDs

- ▷ Do not use self-recorded CDs with labels applied, as these can become detached during playback due to heat buildup and can cause irreparable damage to the device.
- ▷ Only use round CDs with a standard diameter of 4.7 in/12 cm and do not play CDs with an adapter, e.g., single CDs; otherwise, the CDs or the adapter may jam and no longer eject. ◀

### General malfunctions

- ▷ The CD players have been optimized for performance in vehicles. In some instances they may be more sensitive to faulty CDs than stationary devices would be.
- ▷ If a CD cannot be played, first check if it has been inserted correctly.

### Humidity

High levels of humidity can lead to condensation on the CD or the laser's scan lens, and temporarily prevent playback.

### Malfunctions with particular CDs

If malfunctions occur only with particular CDs, this can be due to one of the following causes:

#### Self-recorded CDs

- ▷ Possible reasons for malfunctions with self-recorded CDs are inconsistent data creation

or recording processes, or poor quality or old age of the blank CD.

- ▷ Only label CDs on the upper side with a pen intended for this purpose.

### Damage

- ▷ Avoid fingerprints, dust, scratches and moisture.
- ▷ Store CDs in a sleeve.
- ▷ Do not subject CDs to temperatures over 50 °C/122 °F, high humidity, or direct sunlight.

### CDs with copy protection

CDs are often provided with a copy protection feature by the manufacturer. This can mean that some CDs cannot be played or can only be played to a limited extent.

### MACROVISION

This product contains copyrighted technology that is based on multiple registered US patents and the intellectual property of the Macrovision Corporation and other manufacturers. The use of this copy protection must be approved by Macrovision. Media protected by this product - unless otherwise agreed with Macrovision - may only be used for private purposes. Copying of this technology is prohibited.

## EXTERNAL DEVICES

### AUX-IN port

#### At a glance

- ▷ For connecting audio devices, e.g., MP3 player. The sound is output on the vehicle loudspeakers.
- ▷ Recommendation: use medium tone and volume settings on the audio device. The tone depends on the quality of the audio files.

## Connecting

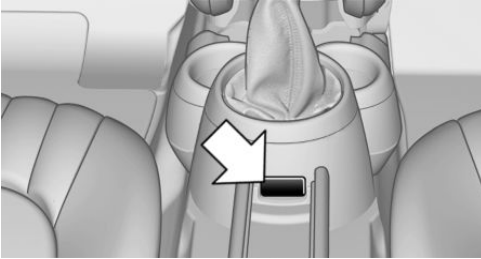

The AUX-IN port is in the center console.

Connect the headphone connector or line-out connector of the device to the AUX-IN port.

Ensure that the connector is inserted all the way into the AUX-IN port.

## Playback

1. Connect the audio device, switch it on and select a track on the audio device.
2.  Press the button.
3. "AUX"

## Volume

The volume of the sound output is dependent on the audio device. If this volume differs markedly from the volume of the other audio sources, it is advisable to adjust the volumes.

## Adjusting the volume

1.  Press the button.
2. "AUX"
3. "Vol-AUX"
4. Connect the audio device, switch it on and select a track on the audio device.

## USB audio interface

### At a glance

It is possible to connect external audio devices. The sound is output on the vehicle loudspeakers.

### Connectors for external devices

- ▷ Connection via USB audio interface: Apple iPod/iPhone, USB devices, e.g., MP3 players, USB flash drives, or mobile phones that are supported by the USB audio interface.
- ▷ External audio devices, e.g. MP3 player: connection via AUX-IN socket.
- ▷ Connection via snap-in adapter, refer to page 143, when equipped with the music interface for smartphones: Apple iPhone or mobile phones.

Playback is only possible if no audio device is connected to the analog AUX-IN port.

Due to the large number of different audio devices available on the market, it cannot be ensured that every audio device/mobile phone is operable on the vehicle. Additional information can be obtained at [www.mini.com/connectivity](http://www.mini.com/connectivity) or from the service center.

### Audio files

Standard audio files can be played back:

- ▷ MP3.
- ▷ WMA.
- ▷ WAV (PCM).
- ▷ AAC, M4A.
- ▷ Playback lists: M3U, WPL, PLS.

### File system

Standard file systems for USB devices are supported. The FAT 32 format is recommended.

## Connecting

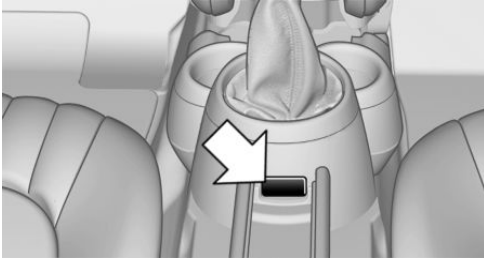

The USB audio interface is in the center console.

### Connection of Apple iPod/iPhone via USB audio interface

To connect the iPod, use the special cable adapter for the Apple iPod. Additional information can be obtained from the service center or on the Internet: [www.mini.com/connectivity](http://www.mini.com/connectivity)

Connect the Apple iPod/iPhone with the AUX-IN port and USB interface.

The Apple iPod/iPhone menu structure is supported by the USB audio interface.

### Connection of a USB device via the USB audio interface

Connect using a flexible adapter cable to protect the USB audio interface and the USB device against physical damage.

Connect the USB device to the USB interface.

### Audio device

Connect the headphone connector or line-out connector of the device to the AUX-IN port of the USB audio interface.

Ensure that the connector is inserted all the way into the AUX-IN port.

### After connecting for the first time

Information on all music tracks, e.g. artist or type of music, as well as playback lists are transmitted into the vehicle. This may take some time, depending on the USB device and the number of tracks.

During transmission, the tracks can be called up via the file directory.

### Number of tracks

Information from up to four USB devices or for approx. 20,000 tracks can be stored in the vehicle. If a fifth device is connected or if more than 20,000 tracks are stored, information on existing tracks may be deleted.

### Copy protection

Music tracks with integrated Digital Rights Management (DRM) cannot be played.

### Playback

1.  Press the button.
2. "IPOD" or "USB" or "AUX"

### Changing the music track

#### Skipping to another track

It is possible to skip to another track within the selected directory.



Press the button repeatedly until the desired track is played.

With the right knob:

Turn the right knob until the desired track is played back.

#### Fast forward/reverse



Hold the button down.

Tracks can be heard but are distorted.

## Random playback



"RND"

To end random playback: "RND"

## Selecting a track

Depending on the connected device, the track can be selected via the following category:

- ▷ "LIST": playback lists.
- ▷ "GEN": musical genre.
- ▷ "ART": artist.
- ▷ "ALB": album.

1. Select the desired category.
2. If necessary, select the desired directory using the right knob.
  - ▷  : press the right knob to open a directory.
  - ▷  : press the right knob to close a directory.
3. Select other directories if you wish.
4. Highlight the desired track and press the right knob.

You can scroll through the directories during playback.

To change to the current track:

"CURR"

## Displaying information on the track

Any information stored on the currently selected track can be displayed.

"TRACK"

## Adjusting the volume

The volume of the sound output is dependent on the audio device. If this volume differs markedly from the volume of the other audio sources, it is advisable to adjust the volumes.

1. "LEV"
2. Turn the right knob until the desired volume is set and press the knob.

## Notes

Do not expose the audio device to extreme environmental conditions, such as very high temperatures; refer to the audio device operating instructions.

Depending on the configuration of the audio files, e.g., bit rates greater than 256 kbit/s, the files may not play back correctly in each case.

## Information on connection

- ▷ It is only possible to connect one iPod/iPhone to the vehicle at a time.
- ▷ Playback from the iPod/iPhone is only possible via the USB audio interface if a snap-in adapter is not used.
- ▷ The connected audio device is supplied with a max. power of 500 mA if supported by the device. Therefore, do not additionally connect the device to a socket in the vehicle; otherwise, playback may be compromised.
- ▷ Do not use force when plugging the connector into the USB interface.
- ▷ Do not connect devices such as fans or lamps to the USB audio interface.
- ▷ Do not connect USB hard drives.
- ▷ Do not use the USB audio interface to recharge external devices.



**CONNECT ME.**



**AT A GLANCE**

**CONTROLS**

**DRIVING TIPS**

**ENTERTAINMENT**

**COMMUNICATION**

**MOBILITY**

**REFERENCE**

# TELEPHONE

## VEHICLE EQUIPMENT

This chapter describes all series equipment as well as country-specific and special equipment offered for this model series. Therefore, it also describes equipment that may not be found in your vehicle, for instance due to the selected special equipment or the country version. This also applies to safety-related functions and systems.

When using the features and systems described here, adhere to local regulations.

## AT A GLANCE

### The concept

Mobile phones can be connected with the vehicle via Bluetooth.

After a suitable mobile phone is paired with the vehicle once, you can operate the mobile phone via the radio, the buttons on the steering wheel, and via voice activation.

Bluetooth® is a registered trademark of Bluetooth® SIG, Inc.

Certain functions may need to be enabled by the mobile phone provider or service provider.

 Using the mobile phone while driving  
Make entries only when traffic and road conditions allow. Do not hold the mobile phone in your hand while you are driving; use the hands-free system instead. If you do not observe this precaution, you can endanger the vehicle occupants and other road users. ◀

### Snap-in adapter

The snap-in adapter is used to:

- ▷ Hold the mobile phone.
- ▷ Recharge the battery.

- ▷ Connect the mobile phone to an outside antenna of the vehicle.

This provides for better network reception and consistent sound quality.

Do not operate a mobile phone that is connected to the vehicle on the mobile phone keypad, as this may lead to a malfunction.

### Approved mobile phones

Details on which mobile phones with a Bluetooth interface are supported by the mobile phone preparation package can be obtained at [www.mini.com/connectivity](http://www.mini.com/connectivity).

### Notes

At high temperatures, the charging function of the mobile phone may be limited and functions may not be executed.

## CONTROLS

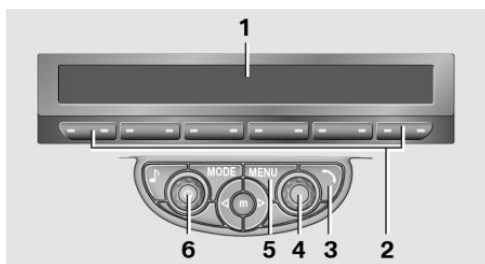

- 1 Display.
- 2 Function buttons for selecting the menu items shown directly above them on the display.
- 3 Redial, accept a call, start dialing, terminate a call and change to the Telephone menu.
- 4 ▷ Turn: highlight the menu item on the display or set the value.

- ▷ Press: select the highlighted menu item or store the setting.
- 5 Opens the main menu.
  - 6 On/off, volume control.

## MENU NAVIGATION

### Selecting menu items

There are two ways to select a menu item on the display.

### Using the right knob

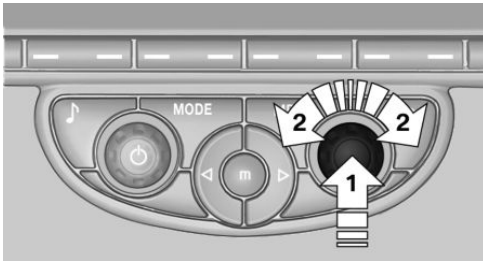

- ▷ To mark a menu item: turn the right knob, arrow 2.
- ▷ To select a menu item: press the right knob, arrow 1.

### Using the function buttons

**SET SC** Press the left or right side of the function button under the menu item.

If only one menu item is displayed above the function button, press the middle of the button.

### Representation in the Owner's Manual

"..." Identifies radio display texts used to select individual functions.

## Symbols on the display

Symbol	Meaning
✓	Function is selected.
←	Leave the menu, one menu back.
◀ ▶	Display additional menu items.
◆	Scroll display. The list contains more than two entries.
📶	Reception of the wireless network: the display depends on the signal strength.
📞	Using the hands-free system.
△	Roaming is active.

## PAIRING/UNPAIRING THE MOBILE PHONE

### Requirements

- ▷ The mobile phone is suitable, refer to page 136.
- ▷ The mobile phone is ready for operation.
- ▷ Bluetooth is activated in the vehicle and on the mobile phone.
- ▷ Bluetooth presettings may need to be made on the mobile phone, e.g., for a connection without confirmation or visibility, refer to the mobile phone operating instructions.
- ▷ A number with at least four and a maximum of 16 digits was defined as the Bluetooth passkey. It is only required once for pairing.
- ▷ The ignition is switched on.

### Activating/deactivating Bluetooth

Bluetooth is not permitted everywhere. Comply with all safety guidelines and regulations.

To activate the connection:

1. Switch on the radio ready state or the ignition.
2.  Press the button.
3. "PHONE"
4. "BT-ON"

To deactivate the connection again:

1. "BT"
2. "BT-OFF"
3. "YES"

## Pairing and connecting

 Pairing the mobile phone

To avoid becoming distracted and posing an unnecessary hazard both to your own vehicle's occupants and to other road users, only pair the mobile phone while the vehicle is stationary. ◀

1. Switch on the radio ready state or the ignition.
2.  Press the button.
3. "PHONE"
4. "BT"
5. "PAIR"

Turn the right knob to display the Bluetooth name of your vehicle.

6. To perform additional steps on the mobile phone, refer to the mobile phone operating instructions: for instance, search for or connect the Bluetooth device or a new device. The Bluetooth name of the vehicle appears on the mobile phone display.
7. Select the Bluetooth name of the vehicle on the mobile phone display.  
You are prompted by the radio or mobile phone to enter the same Bluetooth passkey.

8. Enter the passkey on the mobile phone and confirm it.
9. "ADD"
10. Enter the same passkey on the radio using the function buttons and confirm it.  
To delete the last digit: "DELETE"
11. "OK"

Press twice if necessary.

If pairing was successful, the mobile phone appears on the radio display.

Four mobile phones can be paired with the vehicle at once.

If pairing was unsuccessful: What to do if..., refer to page 139.

## Repeating the pairing procedure/help

If pairing failed:

1. "REPEAT"
2. Repeat steps 6 to 10.

To display the Customer Relations phone number: "CALLS"

Turn the right knob to display the Customer Relations phone number and information needed for pairing.

## Following the initial pairing

- ▷ The mobile phone is detected/connected in the vehicle within a short period of time when the engine is running or the ignition is switched on.
- ▷ The phone book entries of the telephone stored on the SIM card or mobile phone are transmitted to the vehicle after detection, depending on the mobile phone.
- ▷ Specific settings may be necessary in some mobile phones, e.g., authorization or a secure connection; refer to the mobile phone operating instructions.

## Connecting a particular mobile phone

1. Switch on the radio ready state or the ignition.
2.  Press the button.
3. "PHONE"
4. "BT"
5. Turn the right knob until the mobile phone to be connected is displayed.
6. "PRIO"  
Press the button repeatedly until the desired position is reached.

## Unpairing the mobile phone

1. Switch on the radio ready state or the ignition.
2.  Press the button.
3. "PHONE"
4. "BT"
5. Turn the right knob until the mobile phone to be unpaired is displayed.
6. "DELETE"
7. "YES"

## What to do if...

Information on suitable mobile phones, refer to page 136.

The mobile phone could not be paired or connected.

- ▷ Is Bluetooth activated in the vehicle and on the mobile phone? Activate Bluetooth on the vehicle and on the mobile phone.
- ▷ Do the Bluetooth passkeys on the mobile phone and the vehicle match? Enter the same passkey on the mobile phone and on the radio.
- ▷ Did it take longer than 30 seconds to enter the passkey? Repeat the pairing procedure.

- ▷ Are too many Bluetooth devices connected to the mobile phone or vehicle? Delete connections with other devices if necessary.
- ▷ Is the mobile phone in power-save mode or does it have only a limited remaining battery life? Charge the mobile phone in the snap-in adapter or via the charging cable.
- ▷ Depending on the mobile phone, it is possible that only one mobile phone can be connected to the vehicle. Unpair the connected mobile phone from the vehicle and pair and connect only one mobile phone.

The mobile phone no longer reacts?

- ▷ Switch the mobile phone off and on again.
- ▷ Is the ambient temperature too high or low? Do not expose the mobile phone to extreme environmental conditions.

No phone book entries or only some phone book entries are displayed, or they are incomplete.

- ▷ Transmission of the phone book entries is not yet complete.
- ▷ It is possible that only the phone book entries of the mobile phone or the SIM card are transmitted.
- ▷ It may not be possible to display phone book entries with special characters.
- ▷ The number of phone book entries to be stored is too high.
- ▷ Is the data volume of the contact too large, e. g., due to stored information such as notes? Reduce the data volume of the contact.

The phone connection quality is poor.

- ▷ The strength of the Bluetooth signal on the mobile phone can be adjusted, depending on the mobile phone.
- ▷ Insert the mobile phone into the snap-in adapter or place it in the area of the center console.
- ▷ Adjust the volume of the microphone and loudspeakers.

If all points in this list have been checked and the required function is still not available, contact Customer Relations or the service center.

## CONTROLS

- ▷ Accept/reject a call.
- ▷ Dial a phone number.
- ▷ Dial a phone number from the phone book.
- ▷ Dial a stored phone number, such as from the list of accepted calls.
- ▷ End the call.

When the ignition and the radio ready state are switched off, such as after the remote control is removed, an existing call can be continued for up to 25 minutes on the hands-free system.

### Adjusting the volume

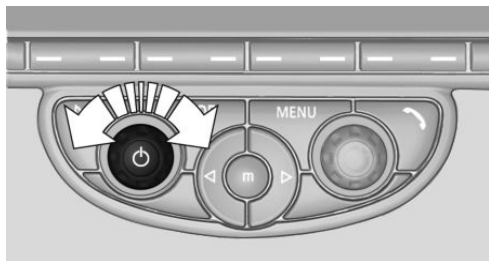

Turn the knob until the desired volume is selected. The setting is stored for the remote control currently in use.

The ringer volume of incoming calls and the call volume can be adjusted independently.

When a call is placed using the hands-free system, the audio sources are muted.

### Switching the microphone to mute

When a call is active, the microphone can be muted.

"MUTE"

A microphone that has been switched to mute is automatically reactivated when a new connection is established.

### Incoming call

#### Receiving calls

If the number of the caller is stored in the phone book and is transmitted by the network, the name of the contact is displayed. Otherwise, only the phone number is displayed.

#### Accepting a call



Briefly press the button on the steering wheel or radio.

or

"YES"

#### Rejecting a call

"NO"

#### Ending a call



Briefly press the button on the steering wheel or radio.

or

"END"

### Entering a phone number

#### Dialing a number

1. Switch on the radio ready state or the ignition.
2.  Press the button.
3. "PHONE"
4. "#"
5. Enter the desired phone number on the buttons 0-9.

To delete the last digit: "DEL"

6.  Briefly press the button on the steering wheel or radio.
- or
- Press the right knob to dial the phone number.

### Phone book

Dialed phone numbers, incoming calls and entries in the phone book are stored on lists if the mobile phone is connected to the vehicle via Bluetooth.

Five lists are available:

- ▷ "A-Z"  
Entries of the phone book of the SIM card or of the mobile phone, which consist of a name and phone number, are sorted in alphabetical order.
- ▷ "TOP8"  
The Top 8 list contains the eight phone numbers that were dialed most frequently.
- ▷ "LAST8"  
The last eight phone numbers that were dialed are stored. The phone number dialed last is at the top of the list.
- ▷ "CALLS"  
The phone numbers of the last eight accepted calls are stored. For this to be possible, it must be possible to transmit the phone number of the caller.
- ▷ "MISSED"  
The phone numbers of the last eight calls that were not accepted are stored. For this to be possible, it must be possible to transmit the phone number of the caller.

### Dialing a phone number from the phone book

The list A-Z is available for phone book entries. If entries with different names but the same phone number are transferred to the vehicle

from the mobile phone, only one entry is displayed.

The display of the phone book entries on the radio may differ from the display on the mobile phone, such as the order of the first and last names.

1. Switch on the radio ready state or the ignition.
2.  Press the button.
3. "PHONE"
4. "A-Z"
5. ◀ ▶ The arrows indicate that additional letters can be displayed.  
Turn the right knob to display additional letters if necessary.
6. Turn the right knob to select the first letter of the entry.
7. Select the entry with the function button.  
The phone number is dialed.

To display all entries:

1. Turn the right knob to select the first letter of the entry and press the knob.
  2. Turn the right knob to select the desired entry and press the knob.
- or



Press the button on the steering wheel or radio to dial the number.

The phone number is dialed.



### Editing and dialing a phone number from the phone book

You can edit the phone number of an entry before making a call. This change is not stored in the phone book.

1. Selecting an entry.
2. "EDIT"
3. To delete a digit: "DEL"

4. Enter additional digits on the buttons 0–9.
5. Press the right knob to dial the phone number.

### Dialing a phone number from the phone book using the buttons on the steering wheel

1.  Press and hold the button to display the Telephone menu.
2. Press the arrow buttons on the steering wheel to leaf through the phone book.
3.  Press the button to dial the phone number.

### Dialing a phone number stored in a list

To select an entry and establish a connection:

1. Switch on the radio ready state or the ignition.
2.  Press the button.
3. "PHONE"
4. Select a list, for instance "TOP8"
5. Turn the right knob to select an entry and press the knob to dial the phone number.

### Deleting an individual entry

1. Select an entry from the list.
2. "DEL"

### DTMF suffix dialing

DTMF suffix dialing can be used for gaining access to network services or for controlling devices, e.g., to make a remote inquiry of an answering machine. The DTMF code is needed for this purpose.

This function is only available if a connection exists and if the hands-free system is being used.

1. "KEYPAD"
2. Enter the DTMF code on the buttons 0–9.

3. If necessary, press and hold the function button on the right or left to enter special characters.

### Displaying the call duration

During a call:

"DURAT"

### Hands-free system

#### General information

Calls that are being made on the hands-free system can be continued on the mobile phone and vice versa.

#### From the mobile phone to the hands-free system

Calls that were begun outside of the Bluetooth range of the vehicle can be continued on the hands-free system with the ignition switched on.

Depending on the mobile phone, the system automatically switches to the hands-free system.

If the system does not switch over automatically, follow the instructions on the mobile phone display; refer also to the mobile phone operating instructions.

#### From the hands-free system to the mobile phone

Calls that are made on the hands-free system can in some cases be continued on the mobile phone; this depends on the mobile phone.

Follow the instructions on the mobile phone display; refer also to the mobile phone operating instructions.

## MINI PHONE NUMBERS

When the ignition is switched on, various service phone numbers can be displayed.



- ▷ "Road Assist": Roadside Assistance, if help is required in the event of a breakdown.
- ▷ "Serv. Appt.": MINI service center, if a service appointment needs to be arranged.
- ▷ "Cust Relat": Customer Relations, for information on all aspects of your vehicle.

### Displaying the phone numbers

1. Switch on the radio ready state or the ignition.
2.  Press the button.
3. "MINI"
4. Turn the right knob until the desired phone number is displayed.

## SNAP-IN ADAPTER

### General information

More information on compatible snap-in adapters that support the functions of the mobile phone is available at the service center.

### Notes

At high temperatures, the charging function of the mobile phone may be limited and functions may not be executed.

When using the mobile phone via the vehicle, note the operating instructions of the mobile phone.

### Installation position

In the center armrest.

### Inserting/removing the snap-in adapter

1. Press the button, arrow 1, and remove the cover, arrow 2.

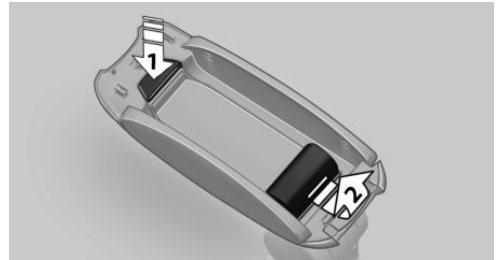

2. Insert the snap-in adapter at the front, arrow 1, and press down, arrow 2, until it engages.

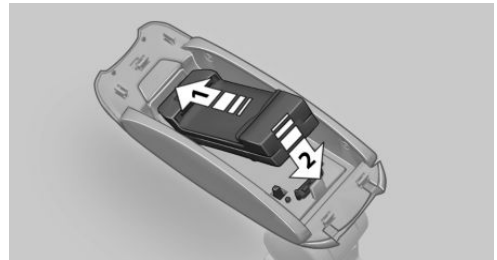

To remove:

To remove the snap-in adapter, press the button.

### Inserting the mobile phone

1. Depending on the mobile phone, remove the protective cap from the antenna connector and from the USB connection of the mobile phone.
2. With the buttons facing up, slide the mobile phone up toward the electrical contacts, ar-

row 1, and press it down until it engages, arrow 2.

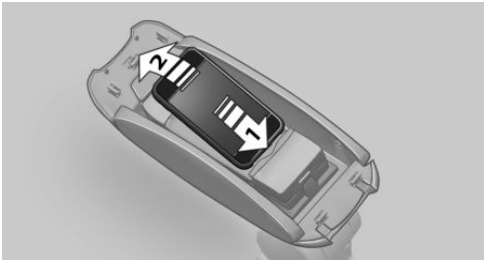

The battery is charged beginning with the radio ready state of the vehicle.

### Removing the mobile phone

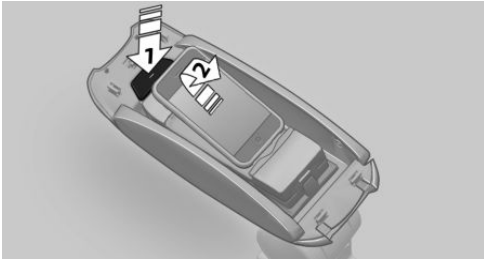

Press the button, arrow 1, and remove the mobile phone, arrow 2.





**MOVE ME.**

**AT A GLANCE**

**CONTROLS**

**DRIVING TIPS**

**ENTERTAINMENT**

**COMMUNICATION**

**MOBILITY**

**REFERENCE**

# REFUELING

## VEHICLE EQUIPMENT

This chapter describes all series equipment as well as country-specific and special equipment offered for this model series. Therefore, it also describes equipment that may not be found in your vehicle, for instance due to the selected special equipment or the country version. This also applies to safety-related functions and systems.

When using the features and systems described here, adhere to local regulations.

## GENERAL INFORMATION

### Refuel promptly

At the latest, refuel at a range below 30 miles/50 km; otherwise, the engine function is not ensured and damage may occur. ◀

## NOTES

 Switch off the engine before refueling  
Always switch off the engine before refueling; otherwise, fuel cannot be added to the tank and a message will be displayed. ◀

-  Observe when handling fuel
- ▷ Take all precautionary measures and observe all applicable regulations when handling fuel.
  - ▷ Do not carry any spare fuel containers in your vehicle. They can develop a leak and cause an explosion or cause a fire in the event of an accident. ◀

## FUEL CAP

### Opening

1. Open fuel filler flap.
2. Turn the fuel cap counterclockwise.
3. Place the fuel cap in the bracket attached to the fuel filler flap.

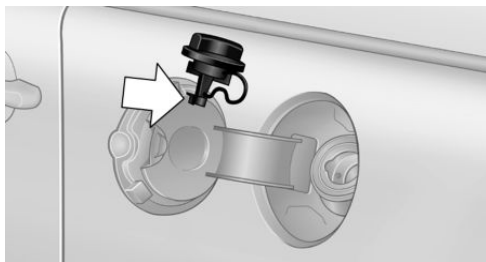

### Closing

1. Fit the fuel cap and turn it clockwise until you clearly hear a click.
2. Close the fuel filler flap.

 Do not pinch the retaining strap  
Do not pinch the retaining strap attached to the cap; otherwise, the cap cannot be closed properly and fuel vapors can escape. ◀

A message is displayed if the cap is loose or missing.

### Manually unlocking fuel filler flap

In the event of a malfunction, the fuel filler flap can be released manually:

MINI Countryman:

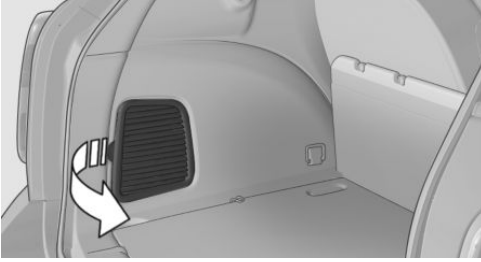

MINI Paceman:

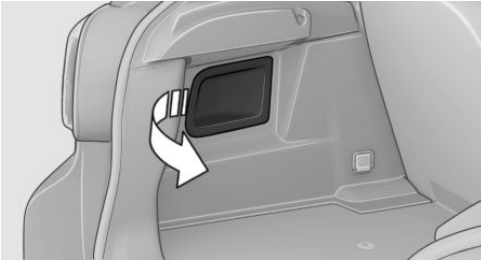

1. Open the cargo area trim, arrow.
2. Pull the green knob with the gas pump symbol.

This opens the fuel filler flap.

## OBSERVE THE FOLLOWING WHEN REFUELING

When refueling, insert the filler nozzle completely into the filler pipe. Lifting up the fuel pump nozzle during refueling causes:

- ▷ Premature pump shutoff.
- ▷ Reduced efficiency in the fuel-vapor recovery system.

The fuel tank is full after refueling is resumed twice after the filler nozzle switches off for the first time.



Do not overfill the fuel tank

Do not overfill the fuel tank; otherwise, escaping fuel may harm the environment or damage the vehicle. ◀



Handling fuels

Follow the safety instructions provided at gas stations; otherwise, there is a danger of personal injury and property damage. ◀

## FUEL TANK CAPACITY

Approx. 12.3 US gal/47 liters, including a reserve capacity of 2.1 US gal/8 liters.

# FUEL

## FUEL RECOMMENDATION

### Vehicle equipment

This chapter describes all series equipment as well as country-specific and special equipment offered for this model series. Therefore, it also describes equipment that may not be found in your vehicle, for instance due to the selected special equipment or the country version. This also applies to safety-related functions and systems.

When using the features and systems described here, adhere to local regulations.

### Gasoline

For the best fuel economy, the gasoline should be sulfur-free or very low in sulfur content.

Do not use fuels that are labeled at the fuel pump as containing metals.

 Only refuel with lead-free gasoline without metal additives

Do not refuel with leaded gasoline or gasoline with metal additives, e. g., manganese or iron; otherwise, the catalytic converter and other components will be permanently damaged. ◀

Fuels with a maximum ethanol content of 10 %, i.e., E10, may be used for refueling.

The ethanol should fulfill the following quality standards:

US: ASTM 4806–xx

CAN: CGSB-3.511–xx

xx: always adhere to the currently applicable standard.

 Do not refuel with ethanol E85

Do not refuel with E85, i.e., fuel with an ethanol content of 85 %, or with Flex Fuel, as this would damage the engine and fuel supply system. ◀

The engine is knock controlled. Therefore, you can refuel with different recommended fuel grades.

### Recommended fuel grade

The manufacturer of your MINI recommends:

- ▷ AKI 91.
- ▷ John Cooper Works AKI 93.

### Minimum fuel grade

The manufacturer of your MINI recommends AKI 89.



Minimum fuel grade

Do not fill up with fuel below the specified minimum quality; otherwise, the engine may not run properly. ◀

If you use gasoline with this minimum AKI rating, the engine may produce knocking sounds when starting at high outside temperatures. This has no effect on the engine life.



Minimum fuel grade

The use of poor-quality fuels may result in harmful engine deposits or damage. Additionally, problems relating to drivability, starting and stalling, especially under certain environmental conditions such as high ambient temperature and high altitude, may occur.

If drivability problems are encountered, we recommend switching to a high quality gasoline brand and a higher octane grade — AKI number — for a few tank fills. To avoid harmful engine deposits, it is highly recommended to purchase gasoline from BP or Top Tier retailers.

Failure to comply with these recommendations may result in the need for unscheduled maintenance. ◀



**MINI** recommends BP fuels 

# WHEELS AND TIRES

## VEHICLE EQUIPMENT

This chapter describes all series equipment as well as country-specific and special equipment offered for this model series. Therefore, it also describes equipment that may not be found in your vehicle, for instance due to the selected special equipment or the country version. This also applies to safety-related functions and systems.

When using the features and systems described here, adhere to local regulations.

## TIRE INFLATION PRESSURE

### Safety information

It is not merely the tires' service life, but also driving comfort and, to a great extent, driving safety that depend on the condition of the tires and the maintenance of the specified tire pressure.

### Checking the pressure

Tires naturally lose pressure uniformly across all four tires.



Check the tire inflation pressure regularly

Regularly check the tire inflation pressure and correct it as needed: at least twice a month and before a long trip. If you fail to observe this precaution, you may be driving on tires with incorrect tire pressures, a condition that may not only compromise your vehicle's driving stability, but also lead to tire damage and the risk of an accident.

Do not drive with depressurized or flat tires, except for run-flat tires. A flat tire will seriously impair your vehicle's handling and braking response. Attempts to drive on a flat tire can lead to a loss of control over the vehicle. ◀

Tires warm up during driving and the tire inflation pressure increases as the temperature rises. The tire inflation pressure specifications apply to cold tires or tires at ambient temperature.

Only check the tire inflation pressure when the tires are cold. This means after a maximum of 1.25 miles/2 km driving or when the vehicle has been parked for at least 2 hours. When the tires are warm, the tire inflation pressure is higher.

After correcting the tire inflation pressure, reset the Tire Pressure Monitor, refer to page 77

or reinitialize the Flat Tire Monitor, refer to page 74.

### Pressure specifications

The tables below provide all the correct inflation pressures for the specified tire sizes at ambient temperature.

The inflation pressures apply to the tire sizes approved and tire brands recommended by the manufacturer of the MINI; a list of these is available from the service center.

For correct identification of the right tire inflation pressures, observe the following:

- ▷ Tire sizes of your vehicle
- ▷ Maximum allowable driving speed

### Tire inflation pressures for driving up to 100 mph or 160 km/h

For normal driving up to 100 mph/160 km/h, adjust pressures to the respective tire inflation pressures listed on the following pages in the column for traveling speeds up to 100 mph/160 km/h to achieve optimum driving comfort.

These tire inflation pressures can also be found on the driver's side door pillar when the driver's door is open.

MINI Countryman:

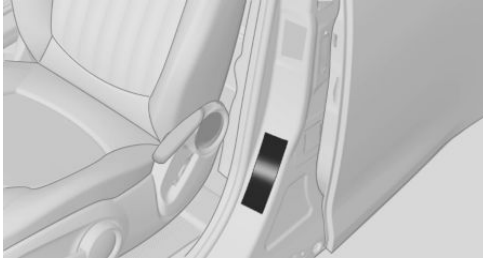

MINI Paceman:

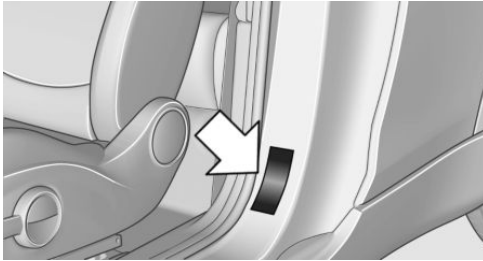

Do not exceed the maximum permissible speed

The permissible maximum speed for these tire inflation pressures is 100 mph/160 km/h. Do not exceed this speed or else there is a risk of tire damage and accidents. ◀

**Tire inflation pressures for driving above 100 mph or 160 km/h**



Adjust the tire inflation pressures

To drive at maximum speeds in excess of 100 mph/160 km/h, adjust pressures to the respective tire inflation pressures listed on the following pages in the column for traveling speeds including those exceeding 100 mph or 160 km/h. Otherwise, tire damage and accidents could occur. ◀



Observe all national and local maximum speed limits; otherwise, violations of the laws could occur.

**Tire inflation pressures for MINI Countryman Cooper**

Tire size	Pressure specifications in bar/PSI				
	Traveling speeds of up to 100 mph/160 km/h		Traveling speeds above 100 mph/160 km/h		
All pressure specifications in the table are indicated in bar/PSI with cold tires. Cold = ambient temperature					
	195/60 R 16 89 H M+S Std	2.2/32	2.2/32	2.4/35	2.4/35
	205/55 R 17 91 H M+S RSC				
	205/55 R 17 91 H M+S A/S RSC				
	205/55 R 17 91 V RSC				
	225/45 R 18 91 V RSC				
	225/40 R 19 89 V RSC				

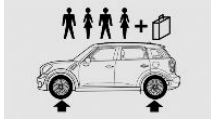

More details on the permissible load and weights, refer to page 207.

### Tire inflation pressures for MINI Countryman Cooper S/Countryman Cooper S ALL4

Tire size	Pressure specifications in bar/PSI			
	Traveling speeds of up to 100 mph/160 km/h		Traveling speeds above 100 mph/160 km/h	
All pressure specifications in the table are indicated in bar/PSI with cold tires. Cold = ambient temperature				
	195/60 R 16 89 H M+S Std	2.2/32	2.2/32	2.6/38
205/55 R 17 91 H M+S RSC				
205/55 R 17 91 H M+S A/S RSC				
205/55 R 17 91 V RSC				
225/45 R 18 91 V RSC				
225/40 R 19 89 V RSC				

More details on the permissible load and weights, refer to page 207.

### Tire inflation pressures for MINI Countryman John Cooper Works

Tire size	Pressure specifications in bar/PSI			
	Traveling speeds of up to 100 mph/160 km/h		Traveling speeds above 100 mph/160 km/h	
All pressure specifications in the table are indicated in bar/PSI with cold tires. Cold = ambient temperature				
	195/60 R 16 89 H M+S Std	2.4/35	2.4/35	2.6/38
225/45 R 18 91 V RSC				
225/45 R 18 91 V M+S A/S RSC				
225/40 R 19 89 V RSC	2.4/35	2.4/35	2.7/39	2.7/39

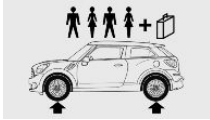
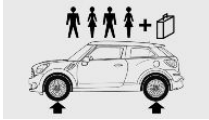

More details on the permissible load and weights, refer to page 207.

## Tire inflation pressures for MINI Paceman Cooper

Tire size	Pressure specifications in bar/PSI			
	Traveling speeds of up to 100 mph/160 km/h		Traveling speeds above 100 mph/160 km/h	
All pressure specifications in the table are indicated in bar/PSI with cold tires. Cold = ambient temperature				
195/60 R 16 89 H M+S Std	2.2/32	2.2/32	2.4/35	2.4/35
205/55 R 17 91 H M+S RSC				
205/55 R 17 91 H M+S A/S RSC				
205/55 R 17 91 V RSC				
225/45 R 18 91 V RSC				
225/40 R 19 89 V RSC				

More details on the permissible load and weights, refer to page [208](#).

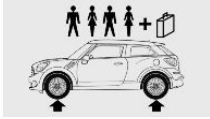
## Tire inflation pressures for MINI Paceman Cooper S / Paceman Cooper S ALL4

Tire size	Pressure specifications in bar/PSI			
	Traveling speeds of up to 100 mph/160 km/h		Traveling speeds above 100 mph/160 km/h	
All pressure specifications in the table are indicated in bar/PSI with cold tires. Cold = ambient temperature				
195/60 R 16 89 H M+S Std	2.2/32	2.2/32	2.6/38	2.6/38
205/55 R 17 91 H M+S RSC				
205/55 R 17 91 H M+S A/S RSC				
205/55 R 17 91 V RSC				
225/45 R 18 91 V RSC				
225/40 R 19 89 V RSC				

More details on the permissible load and weights, refer to page [208](#).

## Tire inflation pressures for MINI Paceman John Cooper Works

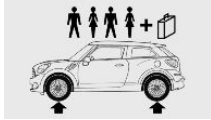
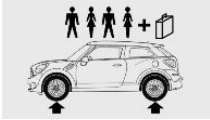
Tire size	Pressure specifications in bar/PSI			
	Traveling speeds of up to 100 mph/160 km/h		Traveling speeds above 100 mph/160 km/h	
All pressure specifications in the table are indicated in bar/PSI with cold tires. Cold = ambient temperature				
195/60 R 16 89 H M+S Std	2.4/35	2.4/35	2.7/39	2.7/39
225/45 R 18 91 V RSC				
225/45 R 18 91 V M+S A/S RSC				
225/40 R 19 89 V RSC				

More details on the permissible load and weights, refer to page [208](#).

## TIRE IDENTIFICATION MARKS

Knowledge of the labeling on the side of the tire makes it easier to identify and choose the right tires.

### Tire size

Example: 225/45 R 17 91 V

225: nominal width in mm

45: aspect ratio in %

R: radial tire code

17: rim diameter in inches

91: load rating, not for ZR tires

### Speed letter

Q = up to 100 mph/160 km/h

T = up to 118 mph/190 km/h

H = up to 131 mph/210 km/h

V = up to 150 mph/240 km/h

W = up to 167 mph/270 km/h

Y = up to 186 mph/300 km/h

### Tire Identification Number

Tires with DOT codes meet the guidelines of the U.S. Department of Transportation.

DOT code:

DOT xxxx xxx 2214

xxxx: manufacturer code for the tire brand

xxx: tire size and tire design

2214: tire age

### Uniform Tire Quality Grading

Quality grades can be found where applicable on the tire sidewall between tread shoulder and maximum section width. For example:

Treadwear 200 Traction AA

Temperature A

### DOT Quality Grades

Treadwear

Traction AA A B C

Temperature A B C



Conform to Federal Safety Requirements  
All passenger car tires must conform to Federal Safety Requirements in addition to these grades. ◀

### Treadwear

The treadwear grade is a comparative rating based on the wear rate of the tire when tested under controlled conditions on a specified government test course. For example, a tire graded 150 would wear one and one-half (1 1/2) times as well on the government course as a tire graded 100. The relative performance of tires depends upon the actual conditions of their use, however, and may depart significantly from the norm due to variations in driving habits, service practices and differences in road characteristics and climate.

### Traction

The traction grades, from highest to lowest, are AA, A, B, and C.

Those grades represent the tire's ability to stop on wet pavement as measured under controlled conditions on specified government test surfaces of asphalt and concrete. A tire marked C may have poor traction performance.

The traction grade assigned to this tire is based on straight-ahead braking traction tests, and does not include acceleration, cornering, hydroplaning, or peak traction characteristics.

### Temperature

The temperature grades are A, the highest, B, and C, representing the tire's resistance to the generation of heat and its ability to dissipate heat when tested under controlled conditions on a specified indoor laboratory test wheel. Sustained high temperature can cause the material of the tire to degenerate and reduce tire life, and excessive temperature can lead to sudden tire failure. The grade C corresponds to a level of performance which all passenger car tires must meet under the Federal Motor Vehi-

cle Safety Standard No. 109. Grades B and A represent higher levels of performance on the laboratory test wheel than the minimum required by law.



Temperature grade for this tire

The temperature grade for this tire is established for a tire that is properly inflated and not overloaded. Excessive speed, underinflation, or excessive loading, either separately or in combination, can cause heat buildup and possible tire failure. ◀

### RSC – Run-flat tires

The symbol identifying run-flat tires is a circle with the letters RSC on the sidewall, refer to page 160.

### M+S

Winter and all-season tires.

These have better winter properties than summer tires.

### XL

Designation for specially reinforced tires.

## TIRE TREAD

### Summer tires

The tread depth should not be less than 0.12 in/3 mm, although European legislation, for example, requires a minimum tread depth of only 0.063 in/1.6 mm. At tread depths less than 0.12 in/3 mm, there is a great danger of hydroplaning even in low water depths and at raised speeds.

### Winter tires

The suitability of winter tires for winter driving is reduced noticeably when their tread depth becomes less than 0.16 in/4 mm.

## Minimum tread depth

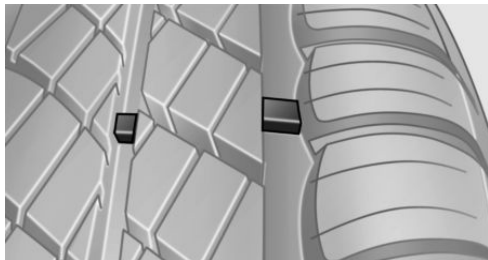

Wear indicators in the tread base are distributed around the circumference of the tire and are marked on the tire sidewall with TWI, Tread Wear Indicator. When the tire tread has been worn down to the wear indicators, a tread has reached a depth of 0.063 in/1.6 mm.

## TIRE DAMAGE

### General information

Inspect your tires often for damage, foreign objects lodged in the tread, and tread wear.

### Notes

Driving over rough or damaged road surfaces, as well as debris, curbs and other obstacles can cause serious damage to wheels, tires and suspension parts. This is more likely to occur with low-profile tires, which provide less cushioning between the wheel and the road. Be careful to avoid road hazards and reduce your speed, especially if your vehicle is equipped with low-profile tires.

Indications of tire damage or other vehicle defects:

- ▷ Unusual vibrations during driving.
- ▷ Unusual handling such as a strong tendency to pull to the left or right.

Damage can be caused by driving over curbs, road damage and similar situations.



In case of tire damage

If there are indications of tire damage, reduce your speed immediately and have the wheels and tires checked right away; otherwise, there is the increased risk of an accident.

Drive carefully to the next service center or tire shop.

If necessary, have the vehicle towed.

Otherwise, tire damage can present a life-threatening hazard to vehicle occupants and other road users. ◀



Repair of tire damage

For safety reasons, the manufacturer of your vehicle recommends that you do not have damaged tires repaired; they should be replaced. Otherwise, damage can occur as a result. ◀

## TIRE AGE

### Recommendation

For several reasons, among other things because of beginning brittleness, the manufacturer of your MINI recommends mounting new tires at the latest after six years, regardless of the actual wear.

### Manufacture date

The date of manufacture of the tires is specified in the tire label:

DOT ... 0315: the tire was manufactured in the 3rd week of 2015.



## CHANGING WHEELS AND TIRES

### Mounting

 Information on mounting tires  
Have mounting and balancing performed only by a service center or tire specialist.

If this work is not carried out properly, there is the danger of subsequent damage and related safety hazards. ◀

### Wheel and tire combination

Information on the right wheel and tire combination and rim version for your vehicle can be obtained from the service center.

Incorrect wheel and tire combinations impair the function of a variety of systems such as ABS or DSC.

To maintain good handling and vehicle response, use only tires with a single tread configuration from a single manufacturer.

Following tire damage, have the original wheel and tire combination remounted on the vehicle as soon as possible.

 Approved wheels and tires  
The manufacturer of your vehicle recommends that you use only wheels and tires that have been approved for your particular vehicle model.

For example, despite having the same official size ratings, variations can lead to body contact and with it, the risk of severe accidents.

The manufacturer of your vehicle cannot evaluate non-approved wheels and tires to determine if they are suited for use, and therefore cannot ensure the operating safety of the vehicle if they are mounted. ◀

### Wheels with electronics for TPM Tire Pressure Monitor

When mounting new tires or changing from summer to winter tires or vice versa, only use wheels with TPM electronics; otherwise, the Tire Pressure Monitor will not be able to detect a flat tire, refer to page 76. Your service center will be glad to advise you.

### Recommended tire brands



For each tire size, the manufacturer of your vehicle recommends certain tire brands. These are indicated by the clearly visible marking on the tire sidewall.

With proper use, these tires meet the highest standards for safety and handling.

### Retreaded tires

The manufacturer of your vehicle does not recommend the use of retreaded tires.

 Retreaded tires  
Possibly substantial variations in the design and age of the tire casing structures can limit service life and have a negative impact on road safety. ◀

### Winter tires

The manufacturer of your vehicle recommends winter tires for winter roads or at temperatures below +45 °F/+7 °C.

Although so-called all-season M+S tires do provide better winter traction than summer tires, they do not provide the same level of performance as winter tires.

### Maximum speed of winter tires

If the maximum speed of the vehicle is higher than the permissible speed for the winter tires, then display a corresponding sign in the field of vision. You can obtain this sign from the tire specialist or from your service center.



Maximum speed for winter tires

Do not exceed the maximum speed for the winter tires; otherwise, tire damage and accidents can occur. ◀

### Run-flat tires

When mounting new tires or changing from summer to winter tires or vice versa, use run-flat tires for your own safety. Also, a compact wheel is not available in case of a flat tire. Your service center will be glad to advise you.

### Rotating wheels between axles

Different wear patterns occur on the front and rear axles, depending on the individual conditions of use.

To ensure even wear on the tires, the wheels can be rotated between the axles. Your service center will be glad to advise you.

After changing the tires, check the tire inflation pressure and correct it if necessary.

### Storage

Store wheels and tires in a cool, dry place with as little exposure to light as possible.

Always protect tires against all contact with oil, grease and fuels.

Do not exceed the maximum tire inflation pressure indicated on the side wall of the tire.

## RUN-FLAT TIRES

### Label



The symbol identifying run-flat tires is a circle with the letters RSC on the sidewall.

Run-flat tires are tires that support themselves for a limited period of time, and they may also come with special rims. The sidewall reinforcement ensures that the tire can continue to be used to a limited extent if it has lost pressure and even if it has become completely desaturated.

For continued driving in the event of a flat tire, refer to page 75.

## CORRECTING A FLAT TIRE



Safety measures in case of a breakdown

- ▶ Park the vehicle as far as possible from passing traffic and on solid ground. Switch on the hazard warning system.
- ▶ Let the steering wheel lock engage with the wheels in the straight-ahead position, set the parking brake, and engage first gear or reverse, or engage selector lever position P.
- ▶ Have all vehicle occupants get out of the vehicle and ensure that they remain outside the immediate area in a safe place, such as behind a guardrail.

- ▷ If a warning triangle or portable hazard warning lamp is required, set it up on the roadside at an appropriate distance from the rear of the vehicle. Comply with all safety guidelines and regulations. ◀

The procedure to correct a flat tire depends on the equipment in the vehicle:

- ▷ Run-flat tires, refer to page 160.
- ▷ MINI Mobility System, refer to page 161.

## MINI MOBILITY SYSTEM

### Notes

- ▷ Follow the instructions on using the Mobility System found on the compressor and sealant bottle.
- ▷ Use of the Mobility System may be ineffective if tire damage is greater than approx. 1/8 in/4 mm in size.
- ▷ Contact the nearest service center if the tire cannot be made drivable.
- ▷ If possible, do not remove foreign bodies that have penetrated the tire.
- ▷ Pull the speed limit sticker off the sealant bottle and apply it to the steering wheel.

### Sealant and compressor



- 1 Sealant bottle and speed limit sticker
  - 2 Filling hose
- Note the use-by date on the sealant bottle.

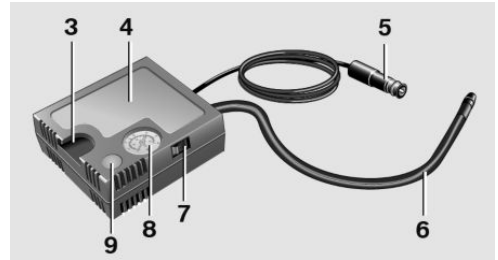

- 3 Holder for the sealant bottle
- 4 Compressor
- 5 Connector and cable for the lighter socket/ socket in passenger compartment 99.
- 6 Connection hose for connecting the compressor and sealant bottle or the compressor and wheel
- 7 On/off switch
- 8 Pressure gauge for displaying the tire inflation pressure
- 9 Release button for reducing the tire inflation pressure

The connector, cable, and connecting hose are stowed in the compressor housing.

### Using the Mobility System

To repair a flat tire with the Mobility System, proceed as follows:

- ▷ Filling the tire with sealant
- ▷ Distributing the sealant
- ▷ Correcting the tire inflation pressure

### Filling the tire with sealant

- ⚠ Adhere to the specified sequence
- Adhere to the specified sequence of the steps; otherwise, sealant may escape under high pressure. ◀

1. Shake the sealant bottle.
2. Pull the connection hose 6 fully out of the compressor housing and screw it onto the sealant bottle connection. Ensure that the connection hose is not kinked.

3. Insert the sealant bottle into the compressor housing in a vertical position.
4. Unscrew the dust cap off of the valve of the defective wheel and screw the filling hose 2 of the sealant bottle onto the valve.

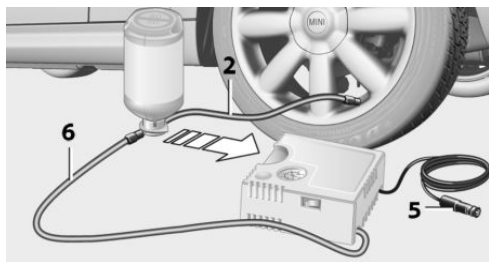

5. Ensure that the compressor is switched off.
6. Insert connector 5 into the lighter socket/ socket in the passenger compartment, refer to page 99.

7. When the engine is running:

Switch on the compressor and let it run for approx. 3 to 8 minutes to fill sealant into the tire and achieve a tire inflation pressure of approx. 1.8 bar/26 psi.

While sealant is being filled, the inflation pressure may intermittently rise to approx. 5 bar/73 psi. Do not switch off the compressor in this phase.

8. Switch off the compressor.

 Do not allow the compressor to run too long

Do not allow the compressor to run longer than 10 minutes; otherwise, the device will overheat and may be damaged. ◀

If an air pressure of 1.8 bar/26 psi is not reached:

1. Unscrew the filling hose 2 from the wheel and drive forward and back approx. 33 ft/10 m to evenly distribute the sealant in the tire.
2. Inflate the tire again using the compressor.

If the inflation pressure of 1.8 bar/26 psi is still not reached, the tire is too heavily damaged. Contact the nearest service center.

### Stowing the Mobility System

1. Unscrew the filling hose 2 of the sealant bottle from the wheel.
2. Unscrew the compressor connection hose 6 from the sealant bottle.
3. Connect the filling hose 2 of the sealant bottle with the free connector on the sealant bottle.

This prevents left-over sealant from escaping from the bottle.

4. Wrap the empty sealant bottle in suitable material to avoid dirtying the cargo area.
5. Stow the Mobility System back in the vehicle.

### Distributing the sealant

Drive approx. 3.1 miles/5 km to evenly distribute the sealant.

Do not exceed a speed of 50 mph/80 km/h. If possible, do not drop below a speed of 10 mph/20 km/h.

### Correcting the tire inflation pressure

1. After driving approx. 3.1 miles/5 km, or about 10 minutes, stop in a suitable location.
2. Screw the connection hose 6 of the compressor directly onto the tire valve.
3. Insert the connector 5 into the power socket in the passenger compartment.
4. Correct the tire inflation pressure to 1.8 bar/26 psi. When the engine is running:
  - ▷ To increase the inflation pressure: switch on the compressor. To check the currently set inflation pressure, switch off the compressor.
  - ▷ To reduce the inflation pressure: press the release button 9.



Do not allow the compressor to run too long

Do not allow the compressor to run longer than 10 minutes; otherwise, the device will overheat and may be damaged. ◀

If the inflation pressure is not maintained, take the vehicle on another drive, distributing the sealant, refer to page 162. Then repeat steps 1 to 4 once.

If the inflation pressure of 1.8 bar/26 psi is still not reached, the tire is too heavily damaged. Contact the nearest service center.

### Continuing the trip



Note the maximum speed

Do not exceed the maximum speed of 50 mph/80 km/h; otherwise, accidents can occur. ◀

Replace the defective tire as soon as possible and have the wheel balanced.

Have the Mobility System refilled.

## SNOW CHAINS

Only certain fine-link snow chains have been tested by MINI, classified as safe for use, and recommended. Consult your service center for more information.

Use only in pairs on the front wheels, equipped with tires of the following size:

195/60 R 16 M+S

With ALL4 all-wheel drive: only mount snow chains on the front wheels.

Observe the manufacturer's instructions when mounting snow chains. Do not exceed a speed of 30 mph or 50 km/h when using snow chains.

Do not initialize the Flat Tire Monitor if snow chains are mounted; otherwise, the instrument might issue an incorrect reading.

Do not initialize the Tire Pressure Monitor if snow chains are mounted; otherwise, the instrument might issue an incorrect reading.

When driving with snow chains, it may be useful to temporarily deactivate DSC or activate DTC, refer to page 81.

# ENGINE COMPARTMENT

## VEHICLE EQUIPMENT

This chapter describes all series equipment as well as country-specific and special equipment offered for this model series. Therefore, it also describes equipment that may not be found in your vehicle, for instance due to the selected

special equipment or the country version. This also applies to safety-related functions and systems.

When using the features and systems described here, adhere to local regulations.

## IMPORTANT FEATURES IN THE ENGINE COMPARTMENT

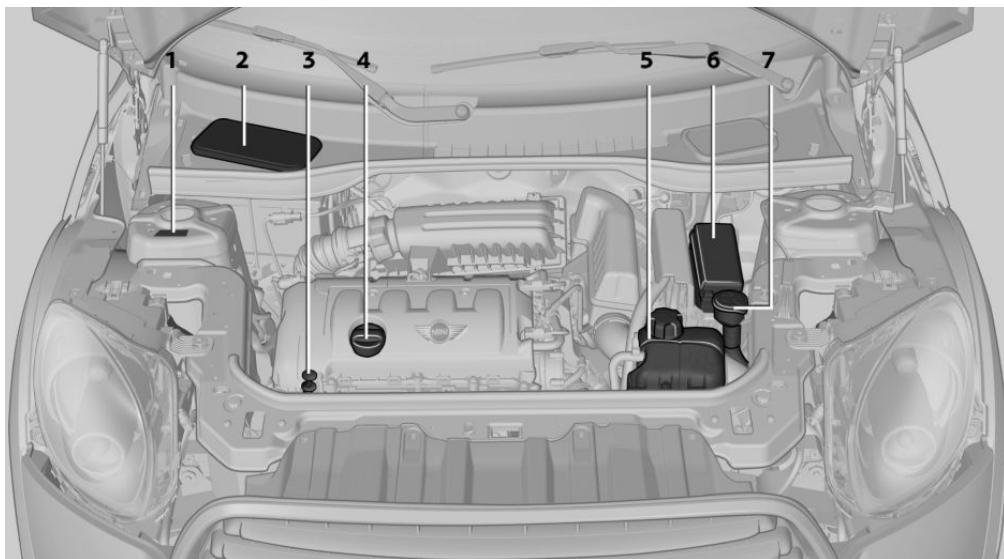

- |   |   |
|---|---|
| <ul style="list-style-type: none"> <li>1 Vehicle identification number</li> <li>2 Battery, under the cover 179</li> <li>3 Dip stick for engine oil 166</li> <li>4 Engine oil filler neck 166</li> </ul> | <ul style="list-style-type: none"> <li>5 Coolant expansion tank 168</li> <li>6 Engine compartment fuse box 179</li> <li>7 Reservoir for washer fluid for the headlight and window washer system 54</li> </ul> |
|---|---|

## HOOD

### Notes

 Working in the engine compartment  
Never attempt to perform any service or repair operations on your vehicle without the necessary professional technical training.

If you are unfamiliar with the statutory guidelines, have any work on the vehicle performed only by a service center.

If this work is not carried out properly, there is the danger of subsequent damage and related safety hazards. ◀

 To avoid damage, make sure that the wiper arms are resting against the windshield before you open the engine compartment. Do not open the engine hood before the engine has cooled down; otherwise, injuries may result. ◀

### Unlocking and opening the hood

1. Pull the lever.

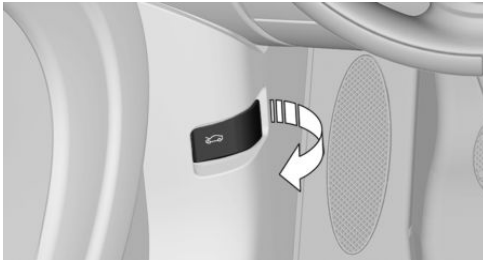

2. Lift the hood all the way.

3. Press the release handle and open the hood.





 Danger of injury when the hood is open  
There is a danger of injury from protruding parts when the hood is open. ◀

### Closing the hood



Close the hood from a height of approx. 16 in/40 cm with momentum. It must be clearly heard to engage.

 Hood open when driving  
If you see any signs that the hood is not completely closed while driving, pull over immediately and close it securely. ◀

 Danger of pinching  
Make sure that the closing path of the hood is clear; otherwise, injuries may result. ◀

# ENGINE OIL

## ENGINE OIL

### Vehicle equipment

This chapter describes all series equipment as well as country-specific and special equipment offered for this model series. Therefore, it also describes equipment that may not be found in your vehicle, for instance due to the selected special equipment or the country version. This also applies to safety-related functions and systems.

When using the features and systems described here, adhere to local regulations.

### General information

Engine oil consumption depends on the driving style and the conditions of use. A highly sporty driving style, for example, results in considerably higher engine oil consumption.

Therefore, regularly check the engine oil level after refueling.

### Checking the oil level with a dip stick

1. Park the vehicle on level ground when the engine is at operating temperature, i.e., after driving continuously for at least 6.2 miles/10 km.
2. Switch the engine off.
3. After approx. 5 minutes, pull out the dip stick and wipe it off with a lint-free cloth, paper towel, etc.
4. Carefully insert the dip stick all the way into the measuring tube and pull it out again.

The oil level must be between the two marks on the dip stick.

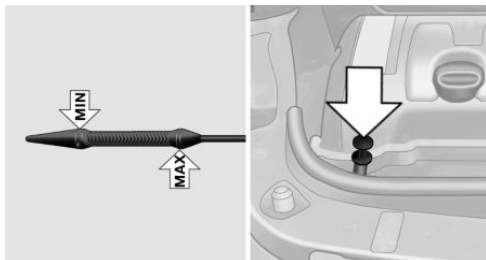

The oil quantity between the two marks on the dip stick equals approx. 1 US quart/1 liter.



Do not exceed the high mark.

Do not exceed the high mark of the dip stick. Overfilling oil damages the engine. ◀

### Adding engine oil

#### Filler neck

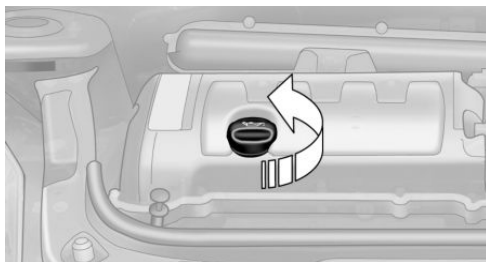

Add a maximum quantity of 1 US quart/1 liter of oil only after the corresponding message appears on the Control Display or, in diesel engines, after the oil level is just above the low mark of the dip stick, refer to page 166.



Add oil promptly

Add oil within the next 30 miles/50 km; otherwise, engine damage could result. ◀





Too much engine oil

Have the vehicle checked immediately; otherwise, surplus oil can lead to engine damage. ◀



Protect children

Keep oil, grease, etc., out of reach of children and heed the warnings on the containers to prevent health risks. ◀

## Oil types for refilling

### Notes



No oil additives

Do not use oil additives as these may cause engine damage. ◀



Viscosity classes of engine oils

When selecting an engine oil, ensure that the engine oil belongs to one of the SAE viscosity classes 0W-40, 0W-30, 5W-40, or 5W-30, or malfunctions or engine damage may occur. ◀

The engine oil quality is critical for the life of the engine.

## Approved oil types

Gasoline engine

BMW High Performance SAE 5W-30

BMW Longlife-01

BMW Longlife-01 FE

Further information on approved oil types can be obtained from the service center.

## Alternative oil types

If the approved engine oils are not available, up to 1 US quart/1 liter of an oil with the following specification can be used:

Gasoline engine

API SM or a higher quality standard

## Engine oil change

The manufacturer of your vehicle recommends having the engine oil changed by a service center.

MINI recommends  
**MINI Original Engine Oil.**

# COOLANT

## VEHICLE EQUIPMENT

This chapter describes all series equipment as well as country-specific and special equipment offered for this model series. Therefore, it also describes equipment that may not be found in your vehicle, for instance due to the selected special equipment or the country version. This also applies to safety-related functions and systems.

When using the features and systems described here, adhere to local regulations.

## GENERAL INFORMATION



Danger of burns from hot engine

Do not open the cooling system while the engine is hot; otherwise, escaping coolant may cause burns. ◀



Suitable additives

Only use suitable additives; otherwise, engine damage may occur. The additives are harmful to your health. ◀

Coolant consists of water and additives.

Not all commercially available additives are suitable for your MINI vehicle. Ask your service center for suitable additives.

## COOLANT TEMPERATURE

If the coolant and therefore the engine overheats, a warning lamp lights up, refer to page 191.

## COOLANT LEVEL

### Checking

1. Do not open the hood until the engine has cooled down.
2. Turn the expansion tank cap counterclockwise slightly to allow any accumulated pressure to escape; then continue turning to open.
3. The coolant level is correct if it is between the markings. The markings are located on the side of the coolant reservoir.

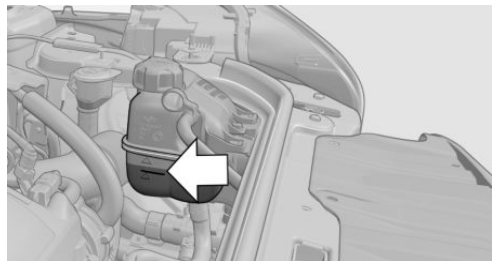

### Refilling

1. Do not open the hood until the engine has cooled down.
2. Turn the expansion tank cap counterclockwise slightly to allow any accumulated pressure to escape, then continue turning to open.
3. If the coolant level is low, slowly add coolant up to the specified level; do not overfill.
4. Twist the cap closed.
5. Have the cause of the coolant loss eliminated as soon as possible.

### Disposal



Comply with the appropriate environmental protection regulations when disposing of coolant additives.

# MAINTENANCE

## VEHICLE EQUIPMENT

This chapter describes all series equipment as well as country-specific and special equipment offered for this model series. Therefore, it also describes equipment that may not be found in your vehicle, for instance due to the selected special equipment or the country version. This also applies to safety-related functions and systems.

When using the features and systems described here, adhere to local regulations.

## MINI MAINTENANCE SYSTEM



The MINI maintenance system provides information on required maintenance measures and thus provides support in maintaining road safety and the operational reliability of the vehicle.

## CONDITION BASED SERVICE CBS

Sensors and special algorithms take into account the various driving conditions of your MINI. Based on this, Condition Based Service determines the current and future maintenance requirements.

The system makes it possible to adapt the amount of maintenance you need to your user profile.

Detailed information on service requirements can be displayed in the tachometer, refer to page 63.

### Service data in the remote control

Information on the required maintenance is continuously stored in the remote control. Your service center will read out this data and suggest the right array of service procedures for your vehicle. Therefore, hand your service specialist the remote control that you used most recently.



Setting the correct date

Make sure the date is set correctly; otherwise, the effectiveness of CBS Condition Based Service is not ensured. ◀

## SERVICE AND WARRANTY INFORMATION BOOKLET FOR US MODELS AND WARRANTY AND SERVICE GUIDE BOOKLET FOR CANADIAN MODELS

Please consult your Service and Warranty Information Booklet for US models and Warranty and Service Guide Booklet for Canadian models for additional information on service requirements.

Maintenance and repair should be performed by your service center. Make sure to have regular maintenance procedures recorded in the vehicle's Service and Warranty Information Booklet for US models, and in the Warranty and Service Guide Booklet for Canadian models. These entries are proof of regular maintenance.

## SOCKET FOR OBD ONBOARD DIAGNOSIS



### Socket for Onboard Diagnosis

The socket for Onboard Diagnosis may only be used by the service center, by workshops that operate according to the specifications of the vehicle manufacturer with appropriately trained personnel, and by other authorized persons. Otherwise, its use may lead to vehicle malfunctions. ◀

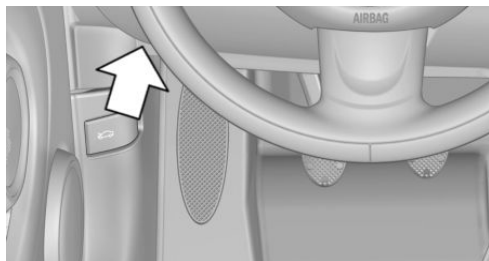

Primary components in the vehicle emissions can be checked via the OBD socket using a device.

## Emissions



The warning lamps light up. The vehicle is producing higher emissions. You can continue your journey, but moderate your speed and exercise due caution. Have the vehicle checked as soon as possible.

Under certain circumstances, one of the lamps flashes or lights up continuously. This indicates that there is excessive misfiring or a malfunction in the engine. If this happens, reduce the vehicle speed and drive to the next service center promptly. Serious engine misfiring within a brief period can seriously damage emission control components, in particular the catalytic converter. In addition, the mechanical engine components may become damaged.



If the fuel filler cap is not properly tightened, the OBD system may conclude

that fuel vapor is escaping; this will cause a display to light up. If the filler cap is then tightened, the display should go out in a few days.

# REPLACING COMPONENTS

## VEHICLE EQUIPMENT

This chapter describes all series equipment as well as country-specific and special equipment offered for this model series. Therefore, it also describes equipment that may not be found in your vehicle, for instance due to the selected special equipment or the country version. This also applies to safety-related functions and systems.

When using the features and systems described here, adhere to local regulations.

## WIPER BLADE REPLACEMENT

### General information

 Do not fold down the wipers without wiper blades

Do not fold down the wipers if wiper blades have not been installed; this may damage the windshield. ◀

### Replacing the front wiper blades

1. Fold up and hold the wiper arm.
2. Squeeze the locking spring, arrows 1, and fold out the wiper blade, arrow 2.



3. Take the wiper blade out of the catch mechanism toward the front.

4. Press the new wiper blade into the fixation until it engages audibly.
5. Fold down the wiper arm.



Risk of damage

Before opening the hood, ensure that the wiper arms with wiper blades are folded onto the window; otherwise, damage may occur. ◀

### Changing the rear wiper blade

MINI Countryman:



MINI Paceman:



1. Fold up and hold the wiper arm.
2. Turn the wiper blade all the way back, arrow.
3. Press the wiper blade against the stop to push it out of the fixation.
4. Press the new wiper blade into the fixation until it engages audibly.
5. Fold down the wiper arm.

## LAMP AND BULB REPLACEMENT

### Notes

#### Lamps and bulbs

Lamps and bulbs make an essential contribution to vehicle safety. Therefore, exercise caution when handling lights and bulbs.

The manufacturer of the vehicle recommends that you entrust corresponding procedures to the service center if you are unfamiliar with them or they are not described here.

You can obtain a selection of replacement bulbs at the service center.

#### Danger of burns

Only change bulbs when they are cool; otherwise, there is the danger of getting burned. ◀

#### Working on the lighting system

When working on the lighting system, you should always switch off the lights affected to prevent short circuits.

To avoid possible injury or equipment damage when replacing bulbs, observe any instructions provided by the bulb manufacturer. ◀

#### Do not touch the bulbs

Do not touch the glass of new bulbs with your bare hands, as even minute amounts of contamination will burn into the bulb's surface and reduce its service life.

Use a clean tissue, cloth or something similar, or hold the bulb by its base. ◀

Caring for the headlights, refer to page 187.

For bulb replacement that is not described here, please contact the service center or a workshop that works according to the repair procedures of the manufacturer with correspondingly trained personnel.

For checking and adjusting headlight aim, please contact your MINI dealer.

#### Light-emitting diodes LEDs

In some equipment, the light source is provided by light-emitting diodes behind a cover.

These light-emitting diodes, which operate using a concept similar to that applied in conventional lasers, are designated as Class 1 light-emitting diodes.



Do not remove the covers

Do not remove the covers, and never stare into the unfiltered light for several hours; otherwise, irritation of the retina could result. ◀

#### Headlight glass

Condensation can form on the inside of the headlights in cool or humid weather. When the light is switched on, the condensation evaporates after a short time. The headlights do not need to be changed.

If the condensation in the headlights does not evaporate after trips with the lights switched on, and the amount of moisture in the headlights increases, for example if water droplets form, have them checked by your service center.

#### Bi-xenon headlights

These bulbs have a very long life and the likelihood of failure is very low, provided that they are not switched on and off excessively. If a bulb should nevertheless fail, you can continue driving cautiously with the front fog lights, provided this is permitted by local laws.



Do not perform work/bulb replacement on xenon headlamps

Have any work on the xenon lighting system, including bulb replacement, performed only by a service center.

Due to the high voltage present in the system, there is the danger of fatal injuries if work is carried out improperly. ◀

## Front lights, bulb replacement

### At a glance

#### Headlights

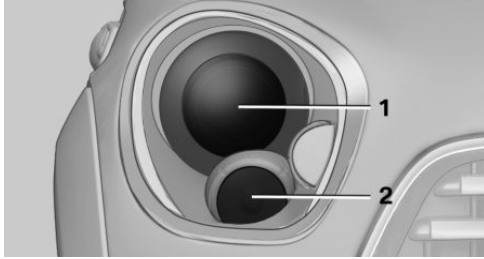

- 1 Low beams/high-beams
- 2 Turn signal

#### Lower front lights

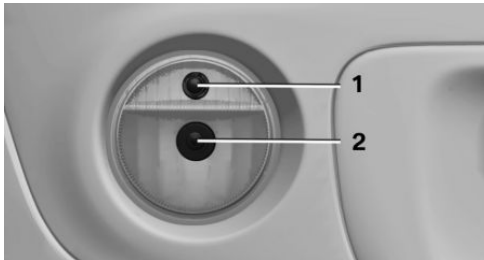

- 1 Parking lights
- 2 Daytime running lights or fog lights

#### Lower LED front lights

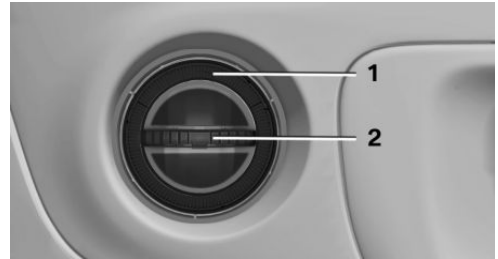

- 1 Parking lights / daytime running lights
- 2 Fog lights

#### Halogen low beams and high-beams

H13 bulb, 60/55 watt

**⚠** Wear protective goggles and gloves  
 Halogen bulbs are pressurized. Therefore, wear protective goggles and gloves. Otherwise, there is a danger of injuries if the bulb is accidentally damaged during replacement. ◀

**⚠** Attach the cover carefully  
 When attaching the cover, proceed carefully; otherwise, leaks may occur, causing damage to the headlamp system. ◀

#### Access to the bulbs through the engine compartment

Follow the general instructions on lamps and bulbs, refer to page 172.

Low beam/high-beam bulbs can be changed from the engine compartment.

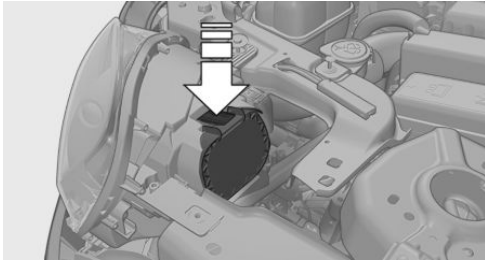

To remove the cover:

1. Press the tab.
2. Fold away the cover and take it out of the holder.

Proceed in reverse order to attach the cover.

 Attach the cover carefully

When attaching the cover, proceed carefully; otherwise, leaks may occur, causing damage to the headlamp system. ◀

### Replacing the bulb

1. Turn the bulb counterclockwise, arrow 1, and remove it, arrow 2.

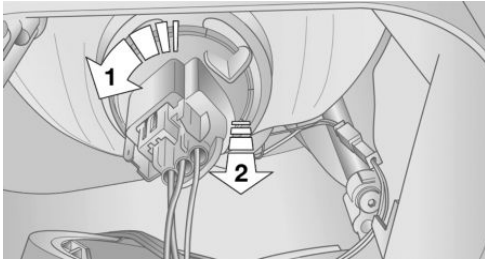

2. Press the release, arrow 1, and pull off the connector, arrow 2.

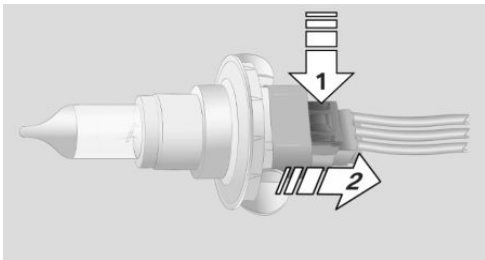

3. Insert the new bulb and attach the cover in reverse order.

### LED parking lights/LED fog lights/LED daytime running lights

Follow the general instructions on lamps and bulbs, refer to page 172.

Lights are implemented using LED technology. Contact your service center in the event of a malfunction.

### Turn signals/parking lights/roadside parking lights/fog lights/and daytime running lights

#### Access to the bulbs via the wheel housing

Follow the general instructions on lamps and bulbs, refer to page 172.

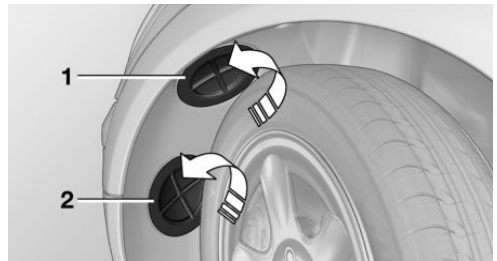

- 1 Turn signal
- 2 Parking lights/roadside parking lights/fog lights/and daytime running lights

### Replacing the turn signal bulb

21-watt bulb, P 21 W, or PY 21 W

1. Turn the wheel.
2. Remove cover 1.

To do this, turn the cover counterclockwise.



3. Remove the inside cover. To do this, turn the cover counterclockwise.

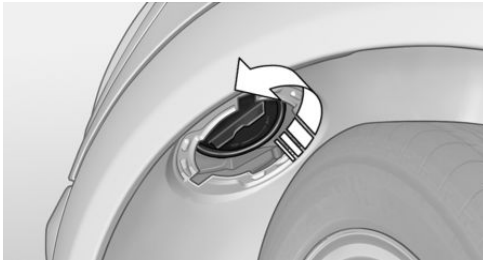

4. Turn the bulb counterclockwise and remove it.

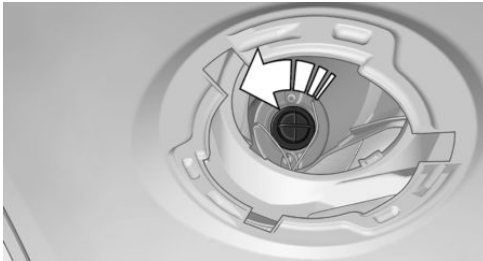

5. Insert the new bulb and attach the covers in reverse order.

### Replacing the parking light bulb and roadside parking light bulb

5-watt bulb, W 5 W

1. Turn the wheel.
2. Remove cover 2.  
To do this, turn the cover counterclockwise.

3. Turn the upper bulb counterclockwise and remove it.

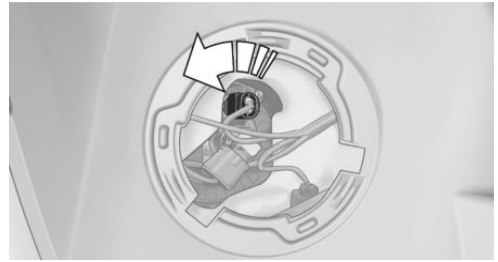

4. Insert the new bulb and attach the cover in reverse order.

### Replacing the front fog light bulb

H8 bulb, 35 watt

1. Turn the wheel.
2. Remove cover 2.  
To do this, turn the cover counterclockwise.
3. Pull off the plug-in cable connector.
4. Turn the lower bulb counterclockwise and remove it.



5. Insert the new bulb and attach the cover in reverse order.

### Replacing the daytime running light bulb

Bulb PSX24W

1. Turn the wheel.
2. Remove cover 2.  
To do this, turn the cover counterclockwise.
3. Pull off the plug-in cable connector.

- Squeeze the lower bulb at both tabs and pull out.

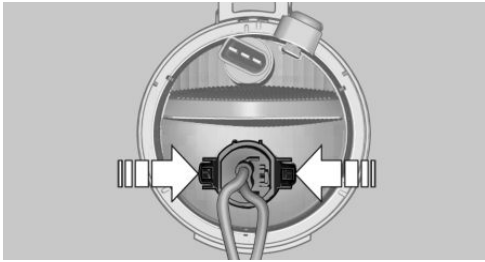

- Insert the new bulb and attach the cover in reverse order.

### Lateral turn signals

5-watt bulb, W 5 W

- Open the hood.

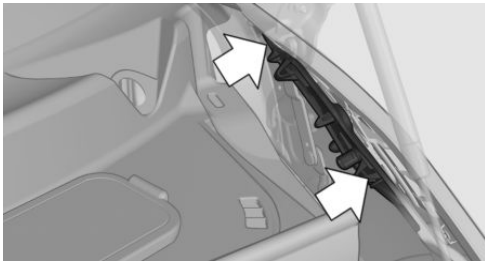

- Squeeze the clip, arrows, and remove the bulb holder.
- Remove the bulb by turning it to the left and replace it.
- Insert the new bulb and attach the cover in reverse order.

### Side marker lights

To replace these bulbs, contact the service center.

### Tail lights, bulb replacement

Follow the general instructions on lamps and bulbs, refer to page 172.

Turn signal: 21-watt bulb, PY 21 W

### MINI Countryman

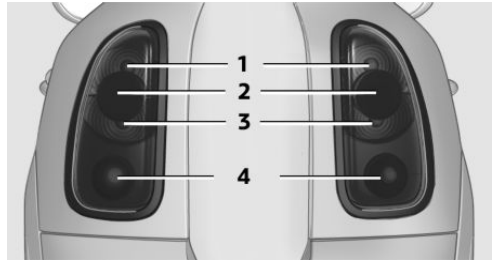

- Brake/tail light
- Turn signal
- Brake/tail light
- Backup light

### MINI Paceman

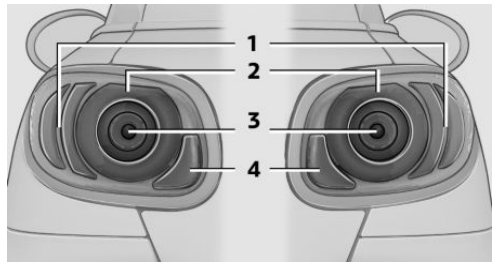

- Brake light
- Tail light
- Turn signal
- Backup light

### Replacing

All bulbs are integrated in a central bulb holder.

### MINI Countryman

- Switch off the lights and take the remote control out of the ignition lock.
- Open the tailgate.

3. Press the cover out of the cargo area side panel at the rear and remove it.



4. Detach the emergency release of the fuel filler flap, refer to page 148, and push it aside with the foam insert. Ensure that the emergency release is not damaged.
5. Disengage the bulb holder by pushing down the clip, arrow 1.

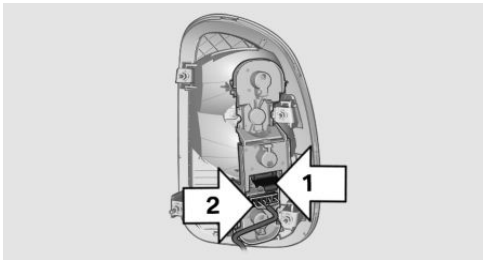

6. Take out the bulb holder and detach the cable, arrow 2.
7. Apply gentle pressure to the bulb while turning it to the left and remove it.
8. Insert the new bulb and mount the bulb holder in reverse order. Ensure that the bulb holder engages in all fasteners.
9. Return the foam insert to its original position and reattach the emergency release of the fuel filler flap.
10. Reattach the cover.

### MINI Paceman

1. Switch off the lights and take the remote control out of the ignition lock.
2. Open the tailgate.
3. Remove the cover from the cargo area side trim.

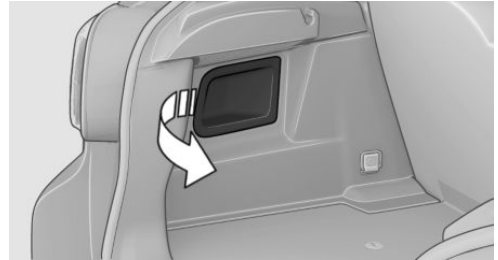

4. Unlock the fastening elements, arrows 1, by turning.

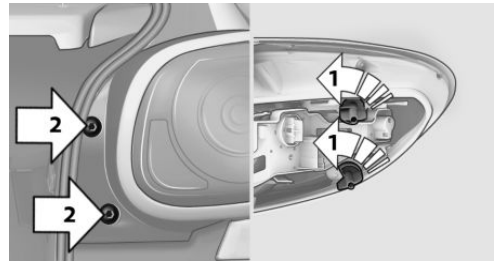

5. Remove the screws, arrows 2, using the hex key from the vehicle document portfolio.
6. Remove the tail light.
7. Disengage the bulb holder by pushing down the clip, arrows 1.

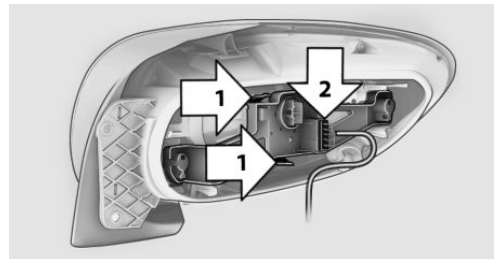

8. Take out the bulb holder and detach the cable, arrow 2.

- Apply gentle pressure to the bulb while turning it to the left and remove it.
- Insert the new bulb and mount the bulb holder in reverse order. Ensure that the bulb holder engages in all fasteners.

### License plate lights

5-watt bulb, C 5 W

#### Replacing

##### MINI Countryman

- Push the light to the left in the catch of the light housing using the screwdriver, arrow 1.



- Take out the light, arrow 2.
- Replace the bulb.
- Insert the light.

##### MINI Paceman

- Push the light to the left in the catch of the light housing using the screwdriver, arrow 1.

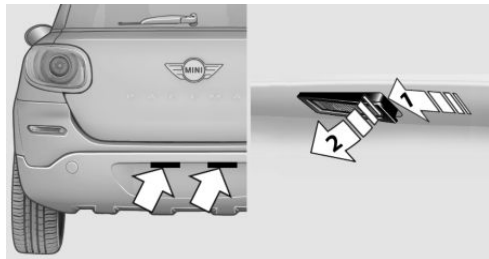

- Take out the light, arrow 2.

- Replace the bulb.
- Insert the light.

### Center brake light

This light uses LED technology for operation. In case of a defect, please contact your service center or a workshop that works according to the repair procedures of the manufacturer of your MINI with correspondingly trained personnel.

## CHANGING WHEELS

#### Notes

The vehicle may be equipped with conventional tires with the Mobility System, refer to page 161, or with run-flat tires, refer to page 160.

No spare tire is available in the case of a flat tire.

Suitable tools for changing the wheels are available from the service center as an accessory.

### Jacking points for the vehicle jack

MINI Countryman:

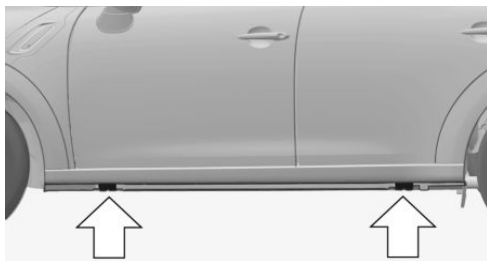

MINI Paceman:

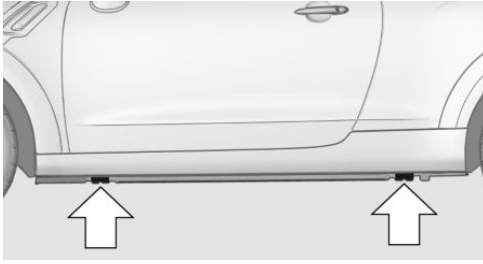

The jacking points for the vehicle jack are located in the positions shown.

## VEHICLE BATTERY

### Maintenance

The battery is maintenance-free, i.e., the electrolyte will last for the life of the battery in temperate climate conditions.

The service center will be happy to answer any questions on the battery.

### Battery replacement



Use approved vehicle batteries

Only use vehicle batteries that have been approved for your vehicle by the manufacturer; otherwise, the vehicle could be damaged and systems or functions may not be fully available. ◀

Have the vehicle battery registered by the service center after it is replaced to ensure that all comfort functions are available without restrictions and that any associated Check Control messages are no longer displayed.

### Charging the battery

#### Note



Do not connect the charger to the socket

Do not connect the battery charger to the socket installed in the vehicle at the factory as this could damage the battery. ◀

Only charge the battery in the vehicle when the engine is switched off. Connections, refer to page 181.

### General information

Ensure that the battery is sufficiently charged to achieve the full battery life.

It may be necessary to charge the battery in the following cases:

- ▶ When the vehicle is frequently used to travel short distances.
- ▶ When the vehicle has not been driven for more than one month.

### Power failure

After a temporary power failure, some equipment will be restricted in its use and will need to be reinitialized. In addition, certain individual settings will be lost and must be updated:

- ▶ Time and date: the values must be updated, refer to page 62.
- ▶ Radio: the stations need to be stored again, refer to page 126.
- ▶ Glass sunroof, electrical: it may only be possible to tilt the roof. The system needs to be initialized. Contact the service center.

### Disposing of old batteries



Have used batteries disposed of by the service center after they are replaced or take them to a recycling center.

Maintain the battery in an upright position for transport and storage. Secure the battery so that it does not tip over during transport.

## FUSES



Replacing fuses

Never attempt to repair a blown fuse and do not replace a defective fuse with a substitute of another color or amperage rating; this

could lead to a circuit overload, ultimately resulting in a fire in the vehicle. ◀

Fuses should be replaced by the service center. Information on the fuses can be found on the inside of the covers.

### In the engine compartment

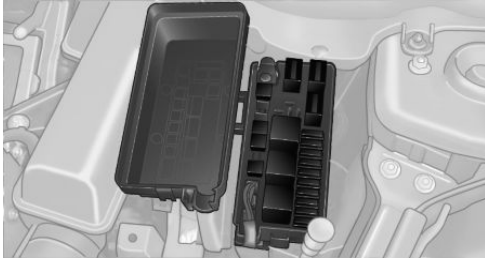

### Opening the cover

Press the snap lock.

### In interior

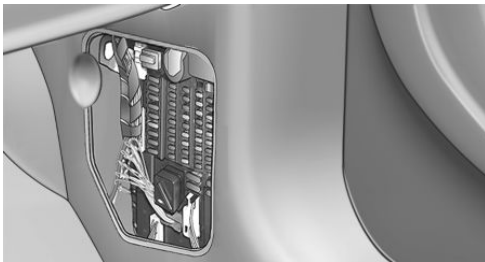

On the right side of the footwell.

### Opening the cover

Push out at the recess.

# BREAKDOWN ASSISTANCE

## VEHICLE EQUIPMENT

This chapter describes all series equipment as well as country-specific and special equipment offered for this model series. Therefore, it also describes equipment that may not be found in your vehicle, for instance due to the selected special equipment or the country version. This also applies to safety-related functions and systems.

When using the features and systems described here, adhere to local regulations.

## HAZARD WARNING FLASHERS



The button is located on the speedometer.

## WARNING TRIANGLE

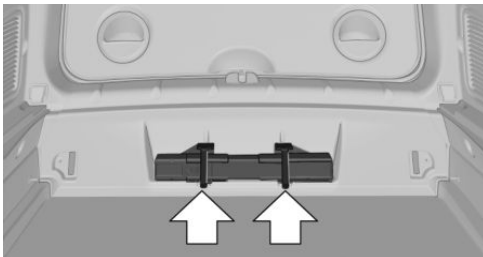

Under the loading edge in the cargo area.

To remove, open the two fasteners.

## FIRST AID KIT

Some of the articles contained in the first aid kit have a limited service life. Therefore, check the use-by dates of the contents regularly and replace the items before they expire.

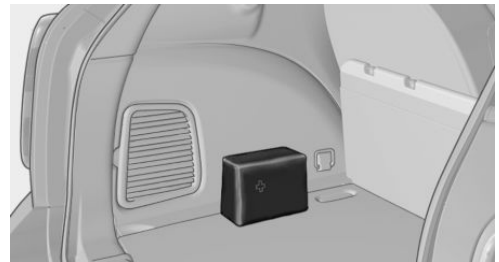

The first aid kit is located in the left side trim on the cargo area floor or under the loading floor.

## ROADSIDE ASSISTANCE

### Service availability

Roadside Assistance can be reached around the clock in many countries. You can obtain assistance there in the event of a vehicle breakdown.

### Roadside Assistance

A phone number for Roadside Assistance can be displayed, refer to page 142, via the radio.

## JUMP-STARTING

### Notes

If the battery is discharged, the engine can be started using the battery of another vehicle and

two jumper cables. In the same way, you can help jump-start another vehicle. Only use jumper cables with fully insulated clamp handles.

To prevent personal injury or damage to both vehicles, adhere strictly to the following procedure.

 **Do not touch live parts**  
To avoid the risk of potentially fatal injury, always avoid all contact with electrical components while the engine is running. ◀

### Preparation

1. Check whether the battery of the other vehicle has a voltage of 12 volts and approximately the same capacitance in Ah. This information can be found on the battery.
2. Switch off the engine of the assisting vehicle.
3. Switch off any electronic systems/power consumers in both vehicles.

 **Bodywork contact between vehicles**  
There must not be any contact between the bodies of the two vehicles, otherwise there is a danger of shorting. ◀

### Connecting jumper cables

 **Connecting order**  
Connect the jumper cables in the correct order; otherwise, there is the danger of injury from sparking. ◀

1. Open the battery cover in the engine compartment to access the positive terminal.

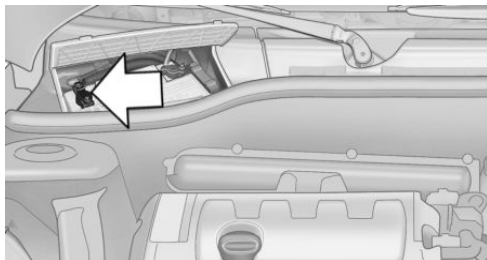

2. Unlock the tabs of the positive terminal cover on the left and right, arrows 1, and raise the cover, arrow 2.

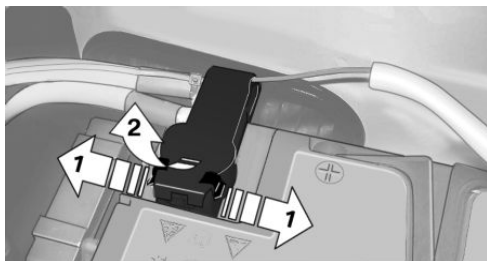

3. Attach one terminal clamp of the positive jumper cable to the positive terminal of the battery or to a starting aid terminal of the vehicle providing assistance.
4. Attach the second clamp of the positive jumper cable to the positive terminal of the battery of the vehicle to be started.
5. Attach one terminal clamp of the negative jumper cable to the negative terminal of the battery, or to the corresponding engine or body ground of the vehicle providing assistance.
6. Attach the second clamp of the negative jumper cable to the negative terminal of



the battery, or to the engine or body ground of the vehicle to be started.

Body ground:

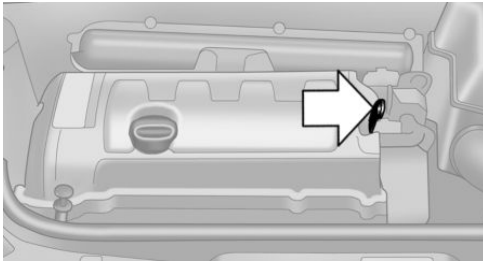

## Starting the engine

Never use spray fluids to start the engine.

1. Start the engine of the assisting vehicle and let it run for several minutes at a slightly increased idle speed.
2. Start the engine of the vehicle being started in the usual way.



If the first starting attempt is not successful, wait a few minutes before making another attempt in order to allow the discharged battery to recharge.



3. Let both engines run for several minutes.
4. Disconnect the jumper cables in the reverse order.

Check the battery and recharge if necessary.

## TOW-STARTING AND TOWING

### Notes

 Observe applicable laws and regulations  
 Observe applicable laws and regulations for tow-starting and towing. ◀

 No additional passengers  
 Do not transport any passengers other than the driver in a vehicle that is being towed. ◀

## Using a tow fitting

The screw-in tow fitting must always be carried in the vehicle. It can be screwed in at the front or rear of the MINI.

The tow fitting is stowed in the following location, depending on the equipment:

- ▷ Under the right or left front seat.
- ▷ In the pouch of the wheel change set in the cargo area.

 Tow fitting, information on use

- ▷ Use only the tow fitting provided with the vehicle and screw it all the way in.
- ▷ Use the tow fitting for towing on paved roads only.
- ▷ Avoid lateral loading of the tow fitting, e.g., do not lift the vehicle by the tow fitting.

Otherwise, damage to the tow fitting and the vehicle can occur. ◀

## Access to the screw thread

Push out the tow fitting cover at the appropriate recess in the bumper.

### Front

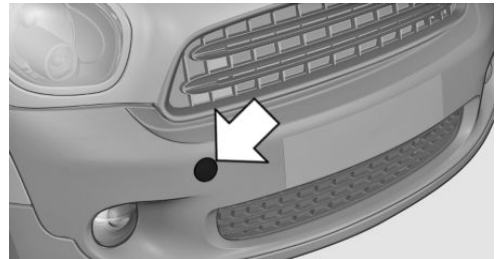

## Rear



## Being towed

 Follow the towing instructions  
Follow all towing instructions, or vehicle damage or accidents may occur. ◀

- ▶ Make sure that the ignition is switched on; otherwise, the low beams, tail lights, turn signals, and windshield wipers may be unavailable.
- ▶ Do not tow the vehicle with the rear axle tilted, as the front wheels could turn.
- ▶ When the engine is stopped, there is no power assist. Consequently, more force needs to be applied when braking and steering.
- ▶ Larger steering wheel movements are required.
- ▶ Switch on the hazard warning system, depending on local regulations.

## Manual transmission

Gearshift lever in neutral position.

## Steptronic transmission

 Towing vehicles with a Steptronic transmission

Only transport vehicles with a Steptronic transmission on tow trucks or with raised front wheels; otherwise, the transmission may be damaged. ◀

## Towing with a tow bar

 Light towing vehicle  
The towing vehicle must not be lighter than your vehicle, or it will not be possible to control vehicle response. ◀

 Correctly attach the tow bar  
Only secure the tow bar on the tow fittings; damage can occur when it is secured on other parts of the vehicle. ◀

The tow fittings used should be on the same side on both vehicles.

Should it prove impossible to avoid mounting the tow bar at an offset angle, please observe the following:

- ▶ Clearance and maneuvering capability will be sharply limited during cornering.
- ▶ The tow bar will generate lateral forces if it is attached offset.

## Towing with a tow rope

When starting to tow the vehicle, make sure that the tow rope is taut.

To avoid jerking and the associated stresses on the vehicle components when towing, always use nylon ropes or nylon straps.

 Attaching the tow rope correctly  
Only secure the tow rope on the tow fitting; otherwise, damage can occur when it is secured on other parts of the vehicle. ◀

## With a tow truck: vehicles without ALL4 all-wheel drive

 Do not lift the vehicle  
Do not lift the vehicle by the tow fitting or body and chassis parts; otherwise, damage may result. ◀

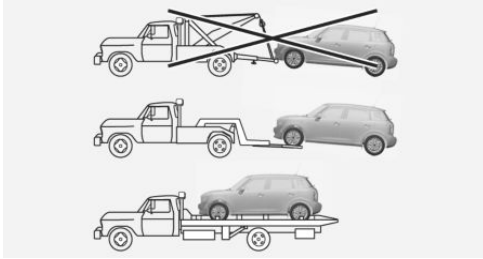
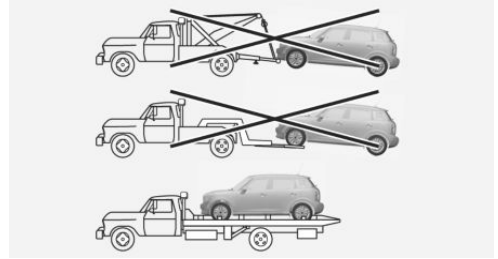
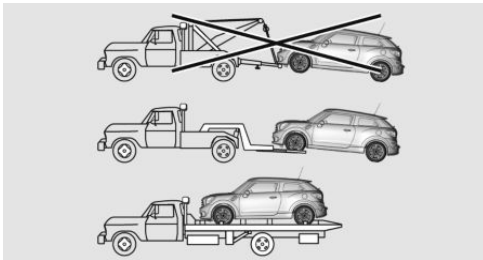
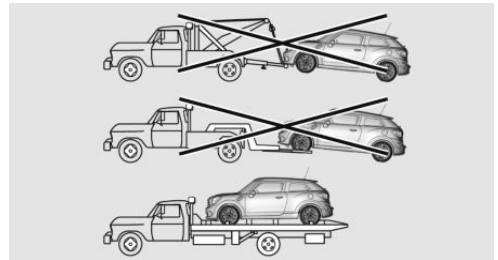
**MINI Countryman:****MINI Countryman:****MINI Paceman:****MINI Paceman:**

Have the vehicle transported with a tow truck with a so-called lift bar or on a flat bed.

Only transport the vehicle on a flat-bed.

**With a tow truck: vehicle with ALL4 all-wheel drive**

Do not lift the vehicle

Do not lift the vehicle by the tow fitting or body and chassis parts; otherwise, damage may result. ◀



Note for vehicles with ALL4 all-wheel drive

Do not tow a vehicle with ALL4 all-wheel drive with just the front or rear axle raised; otherwise, the wheels could lock up and the transfer case could be damaged. ◀

**Tow-starting**

If possible, start the engine by jump-starting, refer to page 181, it rather than tow-starting the vehicle. Vehicles with a catalytic converter should only be tow-started when the engine is cold; vehicles with an automatic transmission cannot be tow-started.

1. Switch on the hazard warning system and comply with local regulations.
2. Switch on the ignition, refer to page 48.
3. Engage third gear.
4. Have the vehicle tow-started with the clutch is depressed and then slowly release the clutch. After the engine starts, immediately depress the clutch completely again.
5. Stop at a suitable location, remove the tow bar or rope, and switch off the hazard warning system.
6. Have the vehicle checked.

# CARE

## VEHICLE EQUIPMENT

This chapter describes all series equipment as well as country-specific and special equipment offered for this model series. Therefore, it also describes equipment that may not be found in your vehicle, for instance due to the selected special equipment or the country version. This also applies to safety-related functions and systems.

When using the features and systems described here, adhere to local regulations.

## CAR WASHES

### Notes

 Steam jets or high-pressure washers

When using steam jets or high-pressure washers, hold them a sufficient distance away and use a maximum temperature of 140 °F/60 °C.

Holding them too close or using excessively high pressures or temperatures can cause damage or preliminary damage that may then lead to long-term damage.

Follow the operating instructions for the high-pressure washer. ◀

Do not direct steam or high-pressure washers toward the labels applied by the manufacturer; otherwise, damage may result.

 Cleaning sensors/cameras with high-pressure washers

When using high-pressure washers, do not spray the seals of the retractable hardtop and the exterior sensors and cameras, for Park Distance Control, for instance, for extended periods of time and only from a distance of at least 12 in/30 cm. ◀



During the winter months

Ensure that the vehicle is washed more frequently in winter. Intense soiling and road salt can damage the vehicle. ◀

After washing the vehicle, apply the brakes briefly to dry them; otherwise, braking action can be reduced and corrosion of the brake discs can occur.

Regularly remove foreign bodies, such as leaves, from the area of the windshield when the hood is open.

### Washing in automatic car washes

Give preference to cloth car washes or those that use soft brushes in order to avoid paint damage.

Do not use automatic high-pressure washers; otherwise, water may drip into the interior in the area of the windows.

Before driving into the car wash, check whether the system is suitable for your MINI. Note the following points:

- ▷ Vehicle dimensions, refer to page 206.
- ▷ If necessary: fold in the exterior mirrors, refer to page 40.
- ▷ Maximum permissible tire width.



Guide rails in car washes

Avoid car washes with guide rails higher than 4 in/10 cm; otherwise, the vehicle chassis could be damaged. ◀

Preparations before driving into the car wash:

- ▷ Unscrew the road antenna.
- ▷ Deactivate the rain sensor to avoid unintentional wiper activation.
- ▷ Deactivate the rear window wiper and protect it from damage. Ask the car wash operator about any necessary protective measures.

- ▶ Remove additional attachments, for instance a spoiler or telephone antenna, if there is a risk that these may be damaged.
- ▶ Insert the remote control into the ignition lock.

### Steptronic transmission

Before driving into the car wash, note the following to ensure that the vehicle can roll:

1. Insert the remote control into the ignition lock, even with Comfort Access.
2. Move the selector lever to position N.
3. Release the parking brake.
4. Switch the engine off.
5. Leave the remote control in the ignition lock so that the vehicle can roll.

### Hand car wash

If washing the vehicle by hand, use copious quantities of water and car shampoo if necessary. Clean the vehicle with a sponge or a washing brush by applying gentle pressure.

Before cleaning the windshield, deactivate the rain sensor to avoid unintentional wiper activation or switch off the ignition.



Adhere to the local regulations regarding washing cars by hand.

### Headlights

Do not rub dry and do not use abrasive or caustic cleansers. Soak areas that have been soiled, e.g., due to insects, with shampoo and rinse off with copious quantities of water.

Thaw ice with a window deicer; do not use an ice scraper.

### Windows

Clean the outside and inside surfaces of the windows and the mirror glasses with window cleaner.

Do not clean mirror glass with cleaners containing quartz.

### Wiper blades

Clean with soapy water and replace regularly to avoid streaking.

Wax and preservative residue and soiling on the windows cause streaking during window wiping and lead to premature wear on the wiper blades and malfunctions of the rain sensor.

## VEHICLE CARE

### Car care products

Regular cleaning and care contributes significantly to vehicle value retention.

The manufacturer recommends using cleaning and care products from MINI, since these have been tested and approved.

Original MINI CareProducts have been tested on materials, in the laboratory, and in the field, and offer optimum care and protection for MINI vehicles.



Do not use cleansers that contain alcohol or solvents

Do not use cleansers that contain alcohol or solvents, such as lacquer thinners, heavy-duty grease removers, fuel, or such; this could lead to surface damage. ◀



Car care and cleaning products

Follow the instructions on the container.

When cleaning the interior, open the doors or windows.

Only use products intended for cleaning vehicles.

Cleansers can contain substances that are dangerous and harmful to your health. ◀

## Vehicle paint

Regular care contributes to vehicle value retention and protects the paintwork against the long-term effects of paint-damaging substances.

Environmental influences in areas with higher air pollution or natural contaminants, such as tree resin or pollen, can have an impact on the vehicle paint. Therefore, it is important to tailor the frequency and extent of your car care to these influences.

Immediately remove especially aggressive substances, such as spilled fuel, oil, grease, or bird droppings, to prevent damage to the paintwork.

## Correcting paint damage

Depending on the severity of the damage, repair stone impact damage or scratches immediately to prevent rust formation.

The manufacturer recommends having paint damage corrected with a professional repair paint job according to factory specifications using original MINI paint materials.

## Preservation

Preservation is needed when water no longer beads off of the clean paint surfaces. Only use paint preservation products that contain carnauba or synthetic waxes.

## Caring for matte finishes

- ▷ Do not use paint cleaners or gloss protection agents such as car wax.
- ▷ Do not polish the surface or use abrasive products, as these may cause the finish to become glossy.

## Leather care

The leather processed by the manufacturer is a high quality natural product. Light graininess is a typical feature of natural leather.

Particles of dust and road grime chafe in pores and folds, and lead to increased wear and premature degradation of the leather surface. Therefore, remove dust from the leather regularly, using a cloth or vacuum cleaner.

Make especially sure that light-colored leather is cleaned regularly as it is more susceptible to soiling.

Twice a year, treat the leather with a leather lotion as dirt and grease will attack the protective layer of the leather.

## Upholstery material care

Vacuum regularly with a vacuum cleaner to remove superficial soiling.

In case of heavy soiling, e.g., beverage stains, use a soft sponge or lint-free microfiber cloth in combination with a suitable interior cleaner. Follow the instructions on the container.

Clean the upholstery material down to the seams using large sweeping motions. Avoid rubbing the material vigorously.



Damage from Velcro® fasteners

Open Velcro® fasteners on pants or other articles of clothing can damage the seat covers. Ensure that any Velcro® fasteners are closed. ◀

## Caring for special components

### Interior plastic parts

These include:

- ▷ Imitation leather surfaces
- ▷ Lamp lenses
- ▷ Indicator covers
- ▷ Matte components

Clean with water and a solvent-free plastic cleaner if necessary.



Do not use cleansers that contain alcohol or solvents

Do not use cleansers that contain alcohol or solvents, such as lacquer thinners, heavy-duty

grease removers, fuel, or such; this could lead to surface damage. ◀

### Rubber seals

Only treat with water or a rubber care product. When cleaning rubber seals, do not use silicone sprays or other care products containing silicone; otherwise, noise and damage may result.

### Chrome surfaces

Carefully clean components such as the radiator grille or door handles with an ample supply of water, possibly with shampoo added, particularly when they have been exposed to road salt. For additional treatment, use a chrome polish.

### Light-alloy wheels

When cleaning the wheels on the vehicle, only use a neutral wheel rim cleaner with a pH value of 5 to 9.

Do not use abrasive cleaners or a steam jet hotter than 140 °F/60 °C; otherwise, damage may result. Adhere to the manufacturer instructions.

Aggressive, acidic, or alkaline cleaners may destroy the protective coating of neighboring components such as the brake disc.

### Exterior sensors

The sensors on the outside of the vehicle, such as for Park Distance Control, must be kept clean and free of ice to ensure that they remain fully functional.

### Decorative trim

Clean decorative trims and fine wood components with a moist cloth only. Then dry with a soft cloth.

### Safety belts

Dirty belt straps impede the reeling action and thus have a negative impact on safety.



No chemical cleaning

Do not clean chemically; this can destroy the webbing. ◀

### Carpets/floor mats



No objects in the area around the pedals

Keep floor mats, carpets, and any other objects out of the area of motion of the pedals; otherwise, the function of the pedals could be impeded while driving

Do not place additional floor mats over existing mats or other objects.

Only use floor mats that have been approved for the vehicle and can be properly fixed in place.

Ensure that the floor mats are securely fastened again when they are returned after being removed, such as for cleaning. ◀

Floor mats can be removed for cleaning.

If they are very dirty, clean with a microfiber cloth and water or an interior cleaner. To prevent matting of the carpet, rub back and forth in the direction of travel only.

### Displays

To clean the displays, such as the radio or display elements, use an antistatic microfiber cloth.



Cleaning displays

Do not use chemical or household cleansers.

Keep all fluids and moisture away from the unit.

Otherwise, they could affect or damage surfaces or electrical components.

Avoid pressing too hard when cleaning and do not use abrasive materials; otherwise, damage can result. ◀

### CD/DVD drives



No cleaning CD

Do not use cleaning CDs; otherwise, parts of the drive may become damaged. ◀

### Long-term vehicle storage

Your service center can advise you on what to consider when storing the vehicle for longer than three months.



# INDICATOR/WARNING LAMPS

## VEHICLE EQUIPMENT

This chapter describes all series equipment as well as country-specific and special equipment offered for this model series. Therefore, it also describes equipment that may not be found in your vehicle, for instance due to the selected



special equipment or the country version. This also applies to safety-related functions and systems.



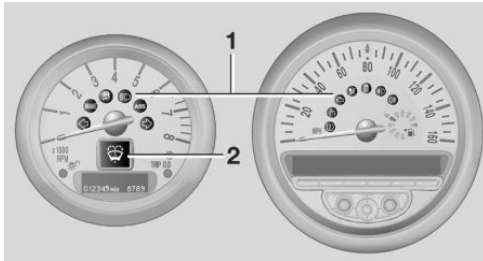







When using the features and systems described here, adhere to local regulations.









## OVERVIEW





















The indicator and warning lights can light up in a variety of combinations and colors in display area 1 or 2. The table contains information on causes and how to respond. Note whether a lamp lights up alone or in combination with another. Some lights can light up in different colors. Corresponding distinctions are made in the text.











1	2	Cause	How to respond
↔		Turn signal	
≡D		The high-beams/headlight flasher are switched on.	
⊘D		The front fog lamps are switched on.	
⊘⊘		The rear fog lights are switched on.	
		Fasten safety belts.	Fasten safety belt, refer to page 39.
		External temperature warning	Drive conservatively, refer to page 58.













1	2	Cause	How to respond
	 <p>Lights up briefly: Approx. 2.1 US gal/8 liters of fuel remain in the tank. Remains on: The remaining range is no more than 30 miles/50 km, refer to page 59.</p>		
	 <p>The engine refuses to start.</p>	<p>Depress the brake or clutch to start the engine, refer to page 49.</p>	
	 <p>The ignition is switched on and driver's door is open.</p>	<p>Switch off the ignition, refer to page 48, or close the driver's door.</p>	
	 <p>The lights are still switched on.</p>	<p>Switch off the lights, refer to page 66.</p>	
	 <p>The roadside parking lamps are still on.</p>	<p>Switch off the roadside parking lights, refer to page 67.</p>	
	 <p>A door is open.</p>		
	 <p>The hood is open.</p>		
	 <p>The tailgate is open.</p>		
	 <p>The fuel cap is missing or loose.</p>	<p>Make sure that the fuel cap is correctly positioned and close it until it clicks audibly. Do not jam the strap between the fuel cap and the vehicle.</p>	
	 <p>The windshield washer fluid level is too low.</p>	<p>Add washer fluid, refer to page 54, as soon as possible.</p>	
	 <p>Lights up in red:  Service is due.</p>	<p>Arrange a service appointment. Check the service requirements, refer to page 169.</p>	





1	2	Cause	How to respond
		Lights up in yellow:	
		The engine will start the next time the Start/ Stop button is touched, possibly without the brake or clutch being depressed.	
		The remote control is malfunctioning or, in cars with Comfort Access, was not detected.	The engine cannot be started. Have the remote control checked, if necessary.
		The battery in the remote control is discharged.	Use the remote control for a longer journey or, in cars with Comfort Access, replace the battery.
		The belt tensioners and/or airbag system has failed.	Have the system checked immediately. Fasten the safety belts anyway.
		Steering assistance has failed.	You can continue your journey, but moderate your speed and exercise due caution. Markedly different steering response. Have the system checked as soon as possible.
		Lights up in red:	
		Engine malfunction	Stop the car and switch off the engine. You cannot continue your journey. Contact your service center.
		Lights up in yellow:	
		Full engine power is no longer available.	You can continue your journey, but moderate your speed and exercise due caution. Have the engine checked as soon as possible.
		Indicator lamp 1 flashes:	
		Engine malfunction under high load. High engine load will result in damage to the catalytic converter.	You can continue your journey, but moderate your speed and exercise due caution. Have the vehicle checked immediately.

1	2	Cause	How to respond
		<p>Indicator lamp 1 lights up:</p> <p>Engine malfunction with adverse effect on emissions.</p>	<p>You can continue your journey, but moderate your speed and exercise due caution. Have the vehicle checked as soon as possible.</p>
			<p>Lights up in red:</p> <p>The engine is overheating.</p> <p>Carefully bring the car to a stop, switch off the engine and allow it to cool down. Do not open the hood; otherwise, there would be a risk of injury due to scalding. Contact your service center.</p>
		<p>Lights up in yellow:</p> <p>The engine is too hot.</p>	<p>Continue driving at more moderate speed so that the engine can cool down. Have the engine checked without delay if the situation reoccurs.</p>
			<p>Lights up in red:</p> <p>Battery is no longer being charged. Alternator malfunction.</p> <p>Switch off all unnecessary electrical consumers. Have the power supply system checked without delay.</p> <p>Lights up in yellow:</p> <p>The battery charge level is very low, the battery is old or is not securely connected.</p> <p>Charge the battery by taking a long drive or using an external charger. If necessary, switch off automatic power consumers. Have the battery checked as soon as possible.</p>
		<p>BRAKE</p> <p>Indication in US models</p> <p>The parking brake is set.</p>	
		 <p>Indication in Canadian models</p> <p>The parking brake is set.</p>	





1	2	Cause	How to respond
BRAKE		Indication in US models The parking brake is set while driving.	Release the parking brake.
		Indication in Canadian models The parking brake is set while driving.	Release the parking brake.
ABS BRAKE 		Indication in US models  Lights up in red: The brake fluid level is too low.	Reduced braking effect, stop the car carefully. Contact the nearest service center.
  		Indication in Canadian models  Lights up in red: The brake fluid level is too low.	Reduced braking effect, stop the car carefully. Contact the nearest service center.
ABS BRAKE		Indication in US models.  Brake pads worn.	Have the condition of the brake pads checked without delay.
 		Indication in Canadian models  Brake pads worn.	Have the condition of the brake pads checked without delay.
ABS BRAKE 		Indication in US models  The vehicle electronics have failed.	You cannot continue your journey. Contact your service center.

1	2	Cause	How to respond
  	 <p>Indication in Canadian models</p> <p>The vehicle electronics have failed.</p>	<p>You cannot continue your journey. Contact your service center.</p>	
	 <p>Lights up in red:</p> <p>The starter has failed or Ignition malfunctioning. The engine can only be restarted when the brake is depressed or Lighting system failed. Low beams/tail lights and brake lights still operational. All other lights failed.</p> <p>Lights up in yellow:</p> <p>Brake light control failed or The fuel supply is malfunctioning.</p> <p>Drive malfunctioning.</p>	<p>Have the system in question checked immediately.</p> <p>The engine cannot be restarted. Depress the brake to restart the engine.</p> <p>You can continue your journey, but moderate your speed and exercise due caution. Have the system in question checked immediately.</p> <p>You can continue your journey, but moderate your speed and exercise due caution. Transmission limp-home program with reduced acceleration is active. Have the system checked immediately.</p>	
	<p>Flashing:</p> <p>Dynamic Stability Control DSC or Dynamic Traction Control DTC is controlling drive and braking forces, refer to page <a href="#">81</a>.</p>		
 OFF	 <p>Dynamic Traction Control DTC is activated, refer to page <a href="#">82</a>.</p>		
 OFF	 <p>Dynamic Stability Control DSC and Dynamic Traction Control DTC are deactivated, refer to page <a href="#">81</a>.</p>	<p>Driving stability limited during acceleration and cornering. Driving style must be readjusted.</p>	

1	2	Cause	How to respond
		Dynamic Stability Control DSC and Dynamic Traction Control DTC failed.	Driving stability limited during acceleration and cornering.  You can continue your journey, but moderate your speed and exercise due caution. Have the system checked as soon as possible.
		ALL4 all-wheel drive failed.	It is possible to continue driving. Drive cautiously and defensively. Avoid operating on poor roads and using the full throttle and kickdown positions of the accelerator. Have the system checked immediately.
		ALL4 all-wheel drive and DSC failed.	It is possible to continue driving. Drive cautiously and defensively. Avoid operating on poor roads and using the full throttle and kickdown positions of the accelerator. Have the system checked immediately.
ABS BRAKE  		Indication in US models  The driving stability control systems including ABS and the Tire Pressure Monitor display have failed, refer to page <a href="#">81</a> .	Reduced braking and driving stability. Drive cautiously and defensively. Avoid full brake application, operation on poor roads, and use of full throttle and kickdown positions of the accelerator. Have the system checked immediately.
ABS BRAKE  		Indication in US models	

1	2	Cause	How to respond
	<p>The driving stability control systems including ABS, ALL4 all-wheel drive, and the Tire Pressure Monitor display have failed, refer to page 81.</p>	<p>Reduced braking and driving stability. Drive cautiously and defensively. Avoid full brake application, operation on poor roads, and use of full throttle and kickdown positions of the accelerator. Have the system checked immediately.</p>	
   	<p>Indication in Canadian models</p>  <p>The driving stability control systems including ABS and the Flat Tire Monitor or the Tire Pressure Monitor have failed, refer to page 81.</p>	<p>Reduced braking and driving stability. Drive cautiously and defensively. Avoid full brake application, operation on poor roads, and use of full throttle and kickdown positions of the accelerator. Have the system checked immediately.</p>	
   	<p>Indication in Canadian models</p>  <p>The driving stability control systems including ABS, ALL4 all-wheel drive, and the Flat Tire Monitor or the Tire Pressure Monitor have failed, refer to page 81.</p>	<p>Reduced braking and driving stability. Drive cautiously and defensively. Avoid full brake application, operation on poor roads, and use of full throttle and kickdown positions of the accelerator. Have the system checked immediately.</p>	
	<p>In vehicles with the Flat Tire Monitor</p>  <p>Light up in yellow and red:</p> <p>A tire is deflated.</p>	<p>Carefully bring the car to a stop. Additional information, refer to page 74.</p>	



1	2	Cause	How to respond
		The Flat Tire Monitor was not initialized.	Initialize the Flat Tire Monitor, refer to page <a href="#">74</a> .
		Light up in yellow: Flat Tire Monitor failed. Punctures are not indicated.	Have the system checked.
		In vehicles with the Tire Pressure Monitor	
		Light up in yellow and red: There is a flat tire or substantial loss of tire pressure.	Carefully bring the car to a stop. Additional information, refer to page <a href="#">76</a> .
		In vehicles with the Tire Pressure Monitor	
		Light up in yellow: Tire Pressure Monitor not initialized.	Check the inflation pressure and reset the system, refer to page <a href="#">76</a> .
		The small light flashes yellow and then stays on, the large light lights up in yellow: Tire Pressure Monitor failed. Punctures are not indicated.	Have the system checked.
		A wheel without TPM electronics is mounted.	Have the system checked.
		TPM is temporarily malfunctioning due to other systems or devices using the same radio frequency.	
		In vehicles with the Tire Pressure Monitor	
		The small light flashes yellow and then stays on, the large light lights up in yellow: Tire Pressure Monitor failed. Punctures are not indicated.	Have the system checked.
		A wheel without TPM electronics is mounted.	Have the system checked.

1

2

Cause

How to respond



Lights up in red:

Transmission limp-home program active with restricted range of gears, possibly with reduced acceleration.

You can continue your journey, but moderate your speed and exercise due caution. Have the system checked immediately.

Gears can be engaged without depressing the brake.

Always depress the brake to engage a gear.

Automatic selector lever locked:

Manually unlock the selector lever lock, refer to page [57](#).

Lights up in yellow:

Have the system checked as soon as possible.

Automatic selector lever locked:

Manually unlock the selector lever lock, refer to page [57](#).

The selector lever is locked in position P with the engine running or the ignition switched on and the brake depressed or

The brake signal is malfunctioning: a gear can be engaged without depressing the brake.

To engage a gear while the vehicle is at a standstill, always depress the brake. Before leaving the vehicle, move the selector lever to position P and switch off the engine.



Lights up in red:













The transmission is overheating.



Bring the car to a stop and move the selector lever to position P. Allow the transmission to cool down. You can continue your journey, but moderate your speed and exercise due caution. Have the system checked if the situation reoccurs.

Lights up in yellow:

The transmission is too hot.

Avoid high engine loads. You can continue your journey, but moderate your speed and exercise due caution.

1	2	Cause	How to respond
		Selector lever position P not engaged. The vehicle is not secured against rolling.	
		Selector lever position P not engaged. The ignition cannot be switched off.	Engage selector lever position P when you wish to switch off the ignition, refer to page 48.
		The cruise control system has failed.	Have the system checked.
		The Park Distance Control has failed.	Have the system checked.
		A bulb of the exterior lighting system has failed.	Have the exterior lighting checked as soon as possible.
		A low-beam headlight or front fog light has failed.	Have the lights checked as soon as possible.
		A high-beam headlight has failed.	Have the high-beam headlights checked.
		A rear fog light has failed.	Have the rear fog lights checked.
		The headlight beam throw adjustment has failed.	Have the headlight beam throw adjustment system checked.
		The Adaptive Light Control has failed.	
		The coolant level is too low.	Add coolant immediately, refer to page 168.
		The engine oil pressure is too low.	Stop immediately and switch off the engine. You cannot continue your journey. Contact your service center.
		Lights up in red:	

1	2	Cause	How to respond
		The service appointment is overdue.	Arrange a service appointment. Check the service requirements, refer to page 63.
		Lights up in yellow: Service is due.	Arrange a service appointment. Check the service requirements, refer to page 63.
		 No service due.	
		 The set speed limit was exceeded.	
		 The time and date are no longer correct.	Set the time and date, refer to page 62.





**FIND ME.**

**AT A GLANCE**

**CONTROLS**

**DRIVING TIPS**

**ENTERTAINMENT**

**COMMUNICATION**

**MOBILITY**

**REFERENCE**

# TECHNICAL DATA

## VEHICLE EQUIPMENT

This chapter describes all series equipment as well as country-specific and special equipment offered for this model series. Therefore, it also describes equipment that may not be found in your vehicle, for instance due to the selected

special equipment or the country version. This also applies to safety-related functions and systems.

When using the features and systems described here, adhere to local regulations.

## NOTE

The technical data and specifications in this Owner's Manual are used as guidance values. The vehicle-specific data can deviate from this, for example, due to the selected special equipment, country version or country-specific measurement method. Detailed values can be

found in the approval documents, on information signs on the vehicle or can be obtained from the service center.

The information in the vehicle documents always has priority.

## DIMENSIONS

The dimensions can vary depending on the model version, equipment or country-specific measurement method.

The specified heights do not take into account attached parts, for example, a roof antenna,

roof racks or spoiler. The heights can deviate, for example, due to the selected special equipment, tires, load and chassis version.

### MINI Countryman

MINI Countryman		Cooper	Cooper S	John Cooper Works
Width with mirrors	inches/mm	78.6/1,996	78.6/1,996	78.6/1,996
Width without mirrors	inches/mm	70.4/1,789	70.4/1,789	70.4/1,789
Height	inches/mm	61.7/1,566	61.7/1,566	61.4/1,560
Length	inches/mm	161.7/4,107	162.2/4,119	163.1/4,143
With aerodynamic bumper	inches/mm	-	163.2/4,144	
Wheelbase	inches/mm	102.2/2,595	102.2/2,595	102.2/2,595
Smallest turning circle dia.	ft/m	38.1/11.6	38.1/11.6	38.1/11.6



## MINI Paceman

MINI Paceman		Cooper	Cooper S	John Cooper Works
Width with mirrors	inches/mm	78.6/1,996	78.6/1,996	78.6/1,996
Width without mirrors	inches/mm	70.3/1,786	70.3/1,786	70.3/1,786
Height	inches/mm	60.4/1,533	60.4/1,533	60.1/1,527
Length	inches/mm	162.2/4,119	162.4/4,124	162.8/4,134
With aerodynamic bumper	inches/mm	-	162.8/4,134	
Wheelbase	inches/mm	102.2/2,596	102.2/2,596	102.2/2,596
Smallest turning circle dia.	ft/m	38.1/11.6	38.1/11.6	38.1/11.6

## WEIGHTS

Never exceed either the approved axle loads or the gross vehicle weight.

### MINI Countryman

		Cooper	Cooper S
Approved gross vehicle weight			
Manual transmission	lbs/kg	3,860/1,751	3,990/1,810
Steptronic transmission	lbs/kg	3,925/1,780	4,035/1,830
Load	lbs/kg	830/376	830/376
Approved front axle load			
Manual transmission	lbs/kg	2,060/934	2,145/973
Steptronic transmission	lbs/kg	2,125/964	2,200/998
Approved rear axle load	lbs/kg	1,920/871	1,920/871
Approved roof load capacity	lbs/kg	165/75	165/75
Cargo area capacity	cu ft/liter	17.5-42.2/ 350-1,170	17.5-42.2/ 350-1,170
		Cooper S ALL4	John Cooper Works
Approved gross vehicle weight			
Manual transmission	lbs/kg	4,100/1,860	4,155/1,885

		Cooper S ALL4	John Cooper Works
Steptronic transmission	lbs/kg	4,145/1,880	4,200/1,905
Load	lbs/kg	830/376	830/376
Approved front axle load			
Manual transmission	lbs/kg	2,210/1,002	2,210/1,002
Steptronic transmission	lbs/kg	2,260/1,025	2,260/1,025
Approved rear axle load	lbs/kg	2,015/914	2,070/939
Approved roof load capacity	lbs/kg	165/75	165/75
Cargo area capacity	cu ft/liter	17.5-42.2/ 350-1,170	17.5-42.2/ 350-1,170

**MINI Paceman**

		Cooper	Cooper S	Cooper S ALL4	John Cooper Works
Approved gross vehicle weight					
Manual transmission	lbs/kg	3,850/1,746	3,960/1,796	4,100/1,860	4,150/1,882
Steptronic transmission	lbs/kg	3,920/1,778	4,010/1,819	4,140/1,878	4,200/1,905
Load	lbs/kg	830/376	830/376	830/376	830/376
Approved front axle load					
Manual transmission	lbs/kg	2,050/930	2,120/962	2,180/989	2,200/998
Steptronic transmission	lbs/kg	2,120/962	2,170/984	2,220/1,007	2,240/1,016
Approved rear axle load	lbs/kg	1,910/866	1,910/866	2,020/916	2,060/934
Approved roof load capacity	lbs/kg	165/75	165/75	165/75	165/75
Cargo area capacity	cu ft/liter	13.9-40.7/ 330-1,080	13.9-40.7/ 330-1,080	13.9-40.7/ 330-1,080	13.9-40.7/ 330-1,080

## CAPACITIES

			Notes
Fuel tank, approx.	US gal/liters	12.4/47	Fuel quality, refer to page <a href="#">150</a>

# EVERYTHING FROM A TO Z

## INDEX

### A

- ABS, Antilock Brake System **81**
- Acoustic signal, refer to Check Control **64**
- Activated charcoal filter with automatic climate control **92**
- Adaptive Light Control **68**
- Additives, engine oil **167**
- Airbags **71**
- Airbags, indicator/warning light **74**
- Air circulation, refer to Recirculated air mode, air conditioner **89**
- Air circulation, refer to Recirculated air mode, automatic climate control **91**
- Air conditioning **88**
- Air conditioning mode, air conditioner **88**
- Air conditioning mode, automatic climate control **90**
- Air distribution, air conditioner, manual **89**
- Air distribution, automatic **91**
- Air distribution, automatic climate control, manual **92**
- Air distribution, individual **89**
- Air drying, refer to Cooling function **92**
- Air flow rate for air conditioner **89**
- Air flow rate with automatic climate control **91**
- Air pressure, refer to Tire inflation pressure **152**
- Air supply, air conditioner **88**
- Air supply, automatic climate control **90**
- Alarm system **30**
- Alarm system, avoiding unintentional alarms **31**
- Alarm system, ending an alarm **30**
- Alarm system, interior motion sensor **31**
- Alarm system, tilt alarm sensor **31**
- ALL4 all-wheel system **83**
- All-wheel drive, refer to ALL4 **83**
- Alternating-code hand-held transmitter **95**
- Ambient lighting **70**
- Antifreeze, washer fluid **54**
- Antilock Brake System, ABS **81**
- Anti-slip control, refer to Dynamic Stability Control **DSC 81**
- Anti-theft protection **21**
- Approved engine oils **167**
- Ashtray **98**
- Assistance, roadside **181**
- Assistance when driving off, refer to Hill drive-off assistant **83**
- Assistance with starting engine, refer to Jump-starting **181**
- Automatic air distribution **91**
- Automatic air flow **91**
- Automatic car wash **186**
- Automatic climate control **90**
- Automatic climate control, automatic air distribution **91**
- Automatic, cruise control **85**
- Automatic headlight control **66**
- Automatic transmission with Steptronic **55**
- AUTO program with automatic climate control **91**
- AUX-IN port **130**
- Average fuel consumption **60**
- Average fuel consumption, setting the units **61**
- Average speed **60**
- Average speed, refer to Computer **59**

### B

- Backrest curvature, refer to Lumbar support **36**
- Backrests, refer to Seats **35**
- Backup lights, bulb replacement **176**
- Battery disposal **30**
- Battery, refer to Vehicle battery **179**
- Battery, remote control **20**
- Battery replacement, remote control **30**
- Belts, refer to Safety belts **37**
- Belt tensioners, refer to Safety belts **37**
- Bi-xenon headlights **172**
- Brake assistant **81**
- Brake discs, breaking in **110**
- Brake fluid, refer to Service requirements **63**
- Brake force distribution, electronic **81**
- Brake pads, breaking in **110**
- Brake, refer to Parking brake **50**

Brakes, MINI maintenance system **169**  
 Brakes, service requirements **63**  
 Brake system, MINI maintenance system **169**  
 Braking, notes **111**  
 Braking, parking brake **50**  
 Breakdown assistance, Road-side Assistance **181**  
 Breaking in **110**  
 Buckle tongue, height adjustment **38**  
 Button for starting the engine, refer to Start/Stop button **48**

## C

California Proposition 65 Warning **7**  
 Car battery, refer to Vehicle battery **179**  
 Car care products **187**  
 Care, displays **189**  
 Care, vehicle **187**  
 Cargo area, Comfort Access **28**  
 Cargo area door, refer to Tailgate **26**  
 Cargo area, enlarging, cargo cover **100**  
 Cargo area, flat loading floor **102**  
 Cargo area light, refer to Interior lights **69**  
 Cargo area, multi-function hook **103**  
 Cargo area, opening from the outside **26**  
 Cargo area, partition net **102**  
 Car horn, refer to Horn **12**  
 Carpet, care **189**  
 Car phone, refer to Telephone **136**  
 Car wash **186**  
 CBC, Cornering Brake Control **81**  
 CBS Condition Based Service **169**  
 CD/DVD drives, care **190**  
 Center armrest **105**  
 Center console, refer to Around the center console **15**  
 Center rail **105**  
 Center rail, refer to Storage compartments **105**  
 Central locking, Comfort Access **28**  
 Central locking from the inside **25**  
 Central locking system, concept **21**  
 Central locking system, from the outside **21**  
 Changes, technical, refer to Safety **6**  
 Changing wheels/tires **159**  
 Check Control **64**  
 Children, transporting **43**  
 Child restraint fixing system LATCH **44**  
 Child restraint fixing systems **43**  
 Child restraint fixing systems, mounting **43**  
 Child seat, mounting **43**  
 Child seats, refer to Transporting children safely **43**  
 Chrome parts, care **189**  
 Circulation of air, refer to Recirculated air mode, air conditioner **89**  
 Circulation of air, refer to Recirculated air mode, automatic climate control **91**  
 Cleaning, displays **189**  
 Cleaning, refer to Care **186**  
 Climate **88**  
 Climate mode, ventilation **93**  
 Clock **58**  
 Clock, 12h/24h mode **61**  
 Closing from the inside **25**  
 Closing, from the outside **22**  
 Clutch, breaking in **110**  
 Cockpit **12**  
 Cold start, refer to Starting the engine **49**  
 Combination instrument, refer to Displays **14**  
 Combination switch, refer to Turn signal/high-beams/headlight flasher **51**  
 Combination switch, refer to Washer/wiper system **52**  
 Comfort Access **28**  
 Comfort Access, in the car wash **29**  
 Comfort Access, replacing the battery **30**  
 Comfort area, refer to Around the center console **15**  
 Compartment for remote control, refer to Ignition lock **48**  
 Compass, digital **96**  
 Computer **59**  
 Computer, displaying information **59**  
 Condition Based Service CBS **169**  
 Confirmation signals for vehicle locking/unlocking **23**  
 Consumption, refer to Average fuel consumption **60**  
 Control Display, care **189**  
 Controls and displays **12**  
 Control systems, driving stability **81**  
 Convenient operation, window **23**  
 Coolant temperature **59**  
 Cooling function, switching on and off **92**  
 Cooling, maximum **91**  
 Cornering Brake Control, CBC **81**  
 Corrosion on brake discs **112**

Cradle for telephone or mobile phone, refer to Snap-in adapter [143](#)  
 Cruise control [85](#)  
 Cupholders [98](#)  
 Current fuel consumption [60](#)  
 Curve lights, refer to Adaptive Light Control [68](#)

## D

Dashboard lighting, refer to Instrument lighting [69](#)  
 Dashboard, refer to Cockpit [12](#)  
 Dashboard, refer to Displays [14](#)  
 Date, display format [61](#)  
 Date, setting [62](#)  
 Daytime running lights [67](#)  
 Decorative trim, care [189](#)  
 Defogging windows [89](#)  
 Defroster, rear window, automatic climate control [92](#)  
 Defroster, rear window, with air conditioner [89](#)  
 Defrosting windows [89](#)  
 Defrost setting, refer to Defrosting windows [89](#)  
 Digital compass [96](#)  
 Dip stick, engine oil [166](#)  
 Directional indicators, refer to Turn signals [51](#)  
 Display lighting, refer to Instrument lighting [69](#)  
 Displays [14](#)  
 Displays and controls [12](#)  
 Displays, care [189](#)  
 Displays, cleaning [189](#)  
 Displays, refer to Instrument cluster [14](#)  
 Disposal, remote control battery [30](#)  
 Distance warning, refer to Park Distance Control PDC [86](#)

Door key, refer to Remote control with integrated key [20](#)  
 Door lock [24](#)  
 Door lock, confirmation signals [23](#)  
 Doors, manual operation [25](#)  
 Doors, unlocking and locking, confirmation signals [23](#)  
 Doors, unlocking and locking from the inside [25](#)  
 Doors, unlocking and locking, from the outside [22](#)  
 DOT Quality Grades [156](#)  
 Drive-off assistant, refer to Hill drive-off assistant [83](#)  
 Driving notes, breaking in [110](#)  
 Driving off on hills, refer to Hill drive-off assistant [83](#)  
 Driving on poor roads [113](#)  
 Driving stability control systems [81](#)  
 Driving tips, refer to Driving notes [110](#)  
 Dry air, refer to Cooling function [92](#)  
 DSC Dynamic Stability Control [81](#)  
 DTC Dynamic Traction Control [82](#)  
 Dynamic Stability Control DSC [81](#)  
 Dynamic Traction Control DTC [82](#)

## E

Electrical malfunction, door lock [25](#)  
 Electrical malfunction, fuel filler flap [148](#)  
 Electronic brake-force distribution [81](#)

Electronic Stability Program ESP, refer to Dynamic Stability Control DSC [81](#)  
 Emergency operation, fuel filler flap, unlocking manually [148](#)  
 Emergency operation, refer to Manual operation [25](#)  
 Emergency operation, Step-tronic transmission, refer to Selector lever lock, overriding [57](#)  
 Energy, saving, refer to Saving fuel [118](#)  
 Engine, breaking in [110](#)  
 Engine compartment [164](#)  
 Engine oil, adding [166](#)  
 Engine oil, additives, refer to Approved engine oils [167](#)  
 Engine oil, alternative oil types [167](#)  
 Engine oil change intervals, refer to Service requirements [63](#)  
 Engine oil, dip stick [166](#)  
 Engine oil, filling capacity [209](#)  
 Engine oil, MINI maintenance system [169](#)  
 Engine oil types, alternative [167](#)  
 Engine oil types, approved [167](#)  
 Engine, overheating, refer to Coolant temperature [59](#)  
 Engine start, assistance [181](#)  
 Engine, starting [49](#)  
 Engine, starting, Comfort Access [28](#)  
 Engine, starting, Start/Stop button [48](#)  
 Engine, stopping, Start/Stop button [48](#)  
 Engine, switching off [50](#)  
 Equipment, interior [94](#)

ESP Electronic Stability Program, refer to Dynamic Stability Control DSC [81](#)  
 Exchanging wheels/tires [159](#)  
 Exterior mirrors [40](#)  
 Exterior mirrors, adjusting [40](#)  
 Exterior mirrors, folding in and out [41](#)  
 Exterior sensors, care [189](#)  
 External temperature display [58](#)  
 External temperature display, changing the units [61](#)  
 External temperature warning [58](#)

## F

Failure messages, refer to Check Control [64](#)  
 False alarm, refer to Avoiding unintentional alarms [31](#)  
 Fan, refer to Air flow rate for air conditioner [89](#)  
 Fan, refer to Air flow rate with automatic climate control [91](#)  
 Fastening safety belts, refer to Safety belts [37](#)  
 Fault messages, refer to Check Control [64](#)  
 Filling capacities [209](#)  
 Filter, refer to Activated-charcoal filter [90](#)  
 Filter, refer to Microfilter [90](#)  
 Filter, refer to Microfilter/activated-charcoal filter with automatic climate control [92](#)  
 First aid kit [181](#)  
 First aid, refer to First aid kit [181](#)  
 Flashing when locking/unlocking [23](#)  
 Flat tire, Flat Tire Monitor [75](#)  
 Flat tire, indicator/warning lamp [75](#)  
 Flat Tire Monitor FTM [74](#)  
 Flat Tire Monitor FTM, flat tire message [75](#)  
 Flat Tire Monitor FTM, initializing the system [74](#)  
 Flat Tire Monitor FTM, snow chains [74](#)  
 Flat Tire Monitor FTM, system limits [74](#)  
 Flat tire, run-flat tire [75](#)  
 Flat tire, Tire Pressure Monitor [76](#)  
 Flat tire, Tire Pressure Monitor TPM [76](#)  
 Flat tire, wheel change [178](#)  
 Floor mats, care [189](#)  
 Fog lights [69](#)  
 Foot brake [111](#)  
 Footwell lights, refer to Interior lights [69](#)  
 Four-wheel drive, refer to ALL4 [83](#)  
 Front airbags [71](#)  
 Front fog light, bulb replacement [174](#)  
 Front fog lights [69](#)  
 Front lights, bulb replacement [173](#)  
 Front passenger airbags, deactivating [72](#)  
 FTM Flat Tire Monitor [74](#)  
 Fuel [150](#)  
 Fuel, additives [150](#)  
 Fuel, average consumption [60](#)  
 Fuel cap, closing [148](#)  
 Fuel consumption display, average fuel consumption [60](#)  
 Fuel filler flap, closing [148](#)  
 Fuel filler flap, opening [148](#)  
 Fuel filler flap, unlocking in case of an electrical malfunction [148](#)  
 Fuel gauge [59](#)

Fuel, refer to Average fuel consumption [60](#)  
 Fuel, saving [118](#)  
 Fuel tank capacity, refer to Filling capacities [209](#)  
 Fuel tank contents, refer to Filling capacities [209](#)  
 Fuel tank, refer to Filling capacities [209](#)  
 Fuse [179](#)

## G

Garage door opener, refer to Integrated universal remote control [94](#)  
 Gasoline [150](#)  
 Gasoline gauge, refer to Fuel gauge [59](#)  
 Gear change, manual transmission [55](#)  
 Gear change, Steptronic transmission [56](#)  
 Gear display, Steptronic transmission [55](#)  
 Glare protection [96](#)  
 Glass sunroof, electrical [31](#)  
 Glass sunroof, electrical, opening/closing [32](#)  
 Glass sunroof, electrical, raising [32](#)  
 Glass sunroof, electric, convenient operation [23](#)  
 Glass sunroof, electric, remote control [23](#)

## H

Halogen headlights, bulb replacement [173](#)  
 Handbrake, refer to Parking brake [50](#)  
 Hand car wash, care [187](#)  
 Hand-held transmitter, alternating code [95](#)  
 Hands-free microphone [15](#)

- Hazard warning system 15
- Head airbags 71
- Headlamp control, refer to Parking lamps/low beams 66
- Headlamps, care 187
- Headlight control, automatic 66
- Headlight courtesy delay feature 68
- Headlight flasher 51
- Headlights 66
- Headlights, cleaning, washer fluid 54
- Head restraints 39
- Head restraints, adjusting the height 39
- Head restraints, removing 40
- Heatable rear window, air conditioner 89
- Heatable windshield 92
- Heating, rear window with automatic climate control 92
- Heating, seats 37
- Heating, windshield 92
- Height adjustment, seats 35
- High-beams 67
- High beams, bulb replacement 173
- Hill drive-off assistant 83
- Hills 112
- Holder for remote control, refer to Ignition lock 48
- Homepage 6
- Hood 165
- Hood, closing 165
- Hood, opening 165
- Hood, unlocking 165
- Horn 12
- Hydraulic brake assistant 81
- I**
- Ice warning, refer to External temperature warning 58
- Icy roads, refer to External temperature warning 58
- Identification marks, run-flat tires 160
- Identification marks, tires 156
- Ignition 49
- Ignition key position 1, refer to Radio ready state 48
- Ignition key position 2, refer to Ignition on 49
- Ignition key, refer to Remote control with integrated key 20
- Ignition lock 48
- Ignition, switched off 49
- Ignition, switched on 49
- Indicator and warning lamps, overview 191
- Indicator and warning lamps, Tire Pressure Monitor TPM 77
- Indicator and warning lights 15
- Individual air distribution 89
- Inflation pressure monitor, refer to Flat Tire Monitor 74
- Inflation pressure monitor, refer to Tire Pressure Monitor TPM 76
- Inflation pressure, refer to Tire inflation pressure 152
- Initializing, compass, refer to Calibrating 97
- Initializing, Flat Tire Monitor FTM 74
- Initializing, glass sunroof, electrical 32
- Instrument cluster, refer to Displays 14
- Instrument lighting 69
- Instruments, refer to Cockpit 12
- Integrated key 20
- Integrated universal remote control 94
- Interior equipment 94
- Interior lights 69
- Interior lights, remote control 24
- Interior mirror 41
- Interior motion sensor 31
- Interior rearview mirror, compass 96
- Interior temperature, setting, air conditioner 88
- Interior temperature, setting, automatic climate control 90
- Internet page 6
- J**
- Jump-starting 181
- K**
- Keyless Go, refer to Comfort Access 28
- Keyless opening and closing, refer to Comfort Access 28
- Key Memory, refer to Personal Profile 20
- Key, refer to Remote control with integrated key 20
- Kickdown, Steptronic transmission 56
- Knee airbag 71
- Knocking control 150
- L**
- Lamp and bulb replacement, bulb replacement 172
- Lamp, replacing, refer to Lamp and bulb replacement 172
- Lamps 66
- Lamps, automatic headlight control 66
- Lap-and-shoulder belt, refer to Safety belts 37



LATCH child restraint fixing system [44](#)  
 Leather, care [188](#)  
 Leather care [188](#)  
 LEDs, light-emitting diodes [172](#)  
 License plate light, bulb replacement [176](#)  
 Light-alloy wheels, care [189](#)  
 Light-emitting diodes, LEDs [172](#)  
 Lighter, socket [98](#)  
 Lighting, instruments [69](#)  
 Lighting, lamp and bulb replacement [172](#)  
 Lighting, vehicle, refer to Lamps [66](#)  
 Lights, parking lamps/low beams [66](#)  
 Light switch [66](#)  
 Lock buttons on doors, refer to Locking [25](#)  
 Locking from the inside [25](#)  
 Locking, from the outside [23](#)  
 Locking, setting the confirmation signal [23](#)  
 Locking the vehicle from the inside [25](#)  
 Locking vehicle, from the outside [22](#)  
 Locking without remote control, refer to Comfort Access [28](#)  
 Longlife oils, alternative oil types [167](#)  
 Longlife oils, refer to Approved engine oils [167](#)  
 Low beams [66](#)  
 Low beams, automatic [66](#)  
 Low beams, bulb replacement [173](#)  
 Lower back support, refer to Lumbar support [36](#)  
 Lumbar support [36](#)

## M

Main inspection, refer to Service requirements [63](#)  
 Maintenance, refer to Service booklet  
 Maintenance, refer to Service requirements [63](#)  
 Maintenance requirements [169](#)  
 Maintenance system MINI [169](#)  
 Makeup mirror [96](#)  
 Malfunction, door lock [25](#)  
 Malfunction, fuel filler flap [148](#)  
 Malfunction, Steptronic transmission [57](#)  
 Malfunction warnings, refer to Check Control [64](#)  
 Manual air distribution, air conditioner [89](#)  
 Manual air distribution, automatic climate control [92](#)  
 Manual mode, Steptronic transmission [56](#)  
 Manual operation, door lock [25](#)  
 Manual operation, fuel filler flap [148](#)  
 Manual operation, selector lever lock, Steptronic transmission [57](#)  
 Marking on approved tires [159](#)  
 Maximum cooling [91](#)  
 Maximum speed, winter tires [160](#)  
 Microfilter [90](#)  
 Microfilter, with automatic climate control [92](#)  
 MINI Homepage [6](#)  
 MINI Internet page [6](#)  
 MINI maintenance system [169](#)  
 MINI Mobility System [161](#)

Minimum tread, tires [158](#)  
 Mirrors [40](#)  
 Mirrors, folding in and out [41](#)  
 Mirrors, interior mirror [41](#)  
 Mobile communication devices in the vehicle [111](#)  
 Mobile phone, refer to Telephone [136](#)  
 Mobility System [161](#)  
 Modifications, technical, refer to Safety [6](#)  
 Mounting of child restraint fixing systems [43](#)

## N

Neck restraints, refer to Head restraints [39](#)  
 New wheels and tires [159](#)  
 Notes [6](#)  
 Nozzles, refer to Ventilation [93](#)

## O

OBD Onboard Diagnostics [170](#)  
 OBD socket, refer to Socket for OBD Onboard Diagnosis [170](#)  
 Octane number, refer to Fuel quality [150](#)  
 Octane rating, refer to Recommended fuel grade [150](#)  
 Odometer [58](#)  
 Oil additives [167](#)  
 Oil level [166](#)  
 Oil types, alternative [167](#)  
 Oil types, approved [167](#)  
 Onboard Diagnostics OBD [170](#)  
 Opening and closing, Comfort Access [28](#)  
 Opening and closing from the inside [25](#)

Opening and closing, from the outside **22**

Opening and closing, using the door lock **24**

Opening and closing, via the remote control **22**

Opening and unlocking from the inside **25**

Outside air mode, automatic climate control **91**

Outside air, refer to Recirculated air mode, air conditioner **89**

Outside air, refer to Recirculated air mode, automatic climate control **91**

Overheating of engine, refer to Coolant temperature **59**

## P

Park Distance Control PDC **86**

Parking aid, refer to Park Distance Control PDC **86**

Parking assistant, refer to Park Distance Control PDC **86**

Parking brake **50**

Parking light, bulb replacement **174**

Parking lights **66**

Parking lights/low beams **66**

PDC Park Distance Control **86**

Personal Profile **20**

Pinch protection, windows **33**

Pivoting sun visor **96**

Plastic, care **188**

Pollen, refer to Microfilter **90**

Pollen, refer to Microfilter/activated-charcoal filter **90**

Pollen, refer to Microfilter/activated-charcoal filter with automatic climate control **92**

Poor road operation **113**

Power windows **33**

Power windows, refer to Windows **32**

Prescribed engine oils, refer to Approved engine oils **167**

Pressure monitoring of tires, refer to Tire Pressure Monitor TPM **76**

Pressure, tires **152**

Pressure warning, tires **74**

Profile depth, refer to Minimum tread depth **158**

Profile, tires **157**

Protective function, refer to Pinch protection system, windows **33**

## R

Radio MINI Boost CD **122**

Radio-operated key, refer to Remote control with integrated key **20**

Radio ready state **48**

Radio ready state, switched off **49**

Radio ready state, switched on **48**

Radio setting, refer to Radio ready state **48**

Rain sensor **52**

Range **60**

Rear **36**

Rear fog light, bulb replacement **176**

Rear lights, refer to Tail lights **176**

Rear seat backrests, foldable, MINI Countryman **100**

Rear seat backrests, foldable, MINI Paceman **101**

Rearview mirror, refer to Mirrors **40**

Rear window defroster with air conditioner **89**

Rear window defroster with automatic climate control **92**

Rear window, washing **54**

Rear window wiper **54**

Recirculated air mode, air conditioner **89**

Recirculated air mode, automatic climate control **91**

Recommended fuel grade **150**

Recommended tire brands **159**

Releasing, refer to Unlocking **28**

Remaining range for service, refer to Service requirements **63**

Remaining range, refer to Range **60**

Remote control **20**

Remote control, battery replacement **30**

Remote control, Comfort Access **28**

Remote control, Comfort Access, malfunctions **29**

Remote control, garage door opener **94**

Remote control, radio interference **24**

Remote control, removing from the ignition lock **48**

Remote control, service data **169**

Remote control, universal **94**

Replacement remote control **20**

Replacing wheels/tires **159**

Reporting safety defects **9**

Reserve warning, refer to Fuel gauge **59**

Reservoir for washer fluid, refer to Washer fluid reservoir **54**

Restraining systems, refer to Safety belts **37**  
 Restraint systems for children **43**  
 Retreaded tires **159**  
 Reverse gear, manual transmission **55**  
 Roadside Assistance **181**  
 Roadside parking light, bulb replacement **174**  
 Roadside parking lights **67**  
 RON recommended fuel grade **150**  
 RON, refer to Fuel quality **150**  
 Rubber seals, care **189**  
 Run-flat tires **160**  
 Run-flat tires, flat tire **75**  
 Run-flat tires, tire inflation pressure **152**

## S

Safe braking **111**  
 Safety **6**  
 Safety belts **37**  
 Safety belts, care **189**  
 Safety belts, damage **39**  
 Safety belts, indicator/warning lamp **39**  
 Safety belts, rear center safety belt **38**  
 Safety belts, reminder **39**  
 Safety systems, airbags **71**  
 Safety systems, safety belts **37**  
 Saving fuel **118**  
 Seat adjustment **36**  
 Seat adjustment, manual **35**  
 Seat heating **37**  
 Seats **35**  
 Seats, adjusting **35**  
 Seats, heating **37**  
 Seats, sitting safely **35**  
 Selector lever lock, overriding **57**  
 Selector lever lock, refer to Selector level positions, changing, shiftlock **56**  
 Selector lever positions, Steptronic transmission **56**  
 Selector lever, Steptronic transmission **56**  
 Service and warranty **7**  
 Service data in the remote control **169**  
 Service interval display, refer to Condition Based Service CBS **169**  
 Service interval display, refer to Service requirements **63**  
 Service requirements **63**  
 Service requirements, CBS Condition Based Service **169**  
 Settings and information **60**  
 Settings, clock **61**  
 Settings, configuring, refer to Personal Profile **20**  
 Shifting, manual transmission **55**  
 Shifting, Steptronic transmission **56**  
 Shift lever, Steptronic transmission **56**  
 Shift paddles on the steering wheel **57**  
 Side airbags **71**  
 Side windows, refer to Windows **32**  
 Sitting safely **35**  
 Sliding/tilting sunroof, refer to Glass sunroof, electrical **31**  
 Slot for remote control **48**  
 Snap-in adapter, mobile phone **143**  
 Snow chains **163**  
 Socket, OBD Onboard Diagnosis **170**  
 Special equipment, series equipment **6**  
 Speed, average **60**  
 Speedometer **14**

Speed, with winter tires **160**  
 Sport button **83**  
 Sport program, Steptronic transmission **56**  
 Stability control systems **81**  
 Start/Stop button **48**  
 Start/Stop button, starting the engine **49**  
 Start/Stop button, switching off the engine **50**  
 Starting the engine **49**  
 Start problems, refer to Jump-starting **181**  
 Steering wheel **42**  
 Steering wheel, adjusting **42**  
 Steering wheel lock **48**  
 Steering wheel, shift paddles **57**  
 Steptronic transmission **55**  
 Steptronic transmission, kick-down **56**  
 Steptronic transmission, overriding the selector lever lock **57**  
 Stopping, engine **50**  
 Storage, tires **160**  
 Storing the vehicle **190**  
 Summer tires, refer to Wheels and tires **152**  
 Summer tires, tread **157**  
 Sun visor **96**  
 Switches, refer to Cockpit **12**  
 Switching off, engine **50**  
 Switching off, vehicle **50**  
 Symbols **6**

## T

Tachometer **59**  
 Tailgate **26**  
 Tailgate, Comfort Access **28**  
 Tailgate, opening/closing **26**  
 Tailgate, opening from the outside **26**  
 Tail lights **176**

- Tank gauge, refer to Fuel gauge [59](#)
- Technical changes, refer to Safety [6](#)
- Telephone [136](#)
- Temperature, air conditioner [89](#)
- Temperature, automatic climate control [92](#)
- Temperature, coolant, refer to Coolant temperature [59](#)
- Temperature display  
– External temperature warning [58](#)
- Temperature display, external temperature [58](#)
- Temperature display, setting the units [61](#)
- Temperature warning [58](#)
- Theft alarm system, refer to Alarm system [30](#)
- Tilt alarm sensor [31](#)
- Time, setting the time [62](#)
- Tire age [158](#)
- Tire, flat tire [75](#)
- Tire identification marks [156](#)
- Tire inflation pressure [152](#)
- Tire inflation pressure, pressure loss, FTM [75](#)
- Tire pressure loss, RDC [77](#)
- Tire, pressure monitoring, refer to Tire Pressure Monitor TPM [76](#)
- Tire pressure monitor, refer to Flat Tire Monitor [74](#)
- Tire Pressure Monitor TPM [76](#)
- Tire Pressure Monitor TPM, system limits [79](#)
- Tire Pressure Monitor TPM, system reset [77](#)
- Tire Pressure Monitor TPM, warning lamp [77](#)
- Tire Quality Grading [156](#)
- Tires, breaking in [110](#)
- Tires, changing [159](#)
- Tires, condition [157](#)
- Tires, damage [158](#)
- Tire size [156](#)
- Tires, minimum tread [158](#)
- Tires, retreaded tires [159](#)
- Tires, storage [160](#)
- Tire tread [157](#)
- Towing another vehicle [183](#)
- Towing, being towed [183](#)
- Tow-starting [183](#)
- TPM, refer to Tire Pressure Monitor [76](#)
- Traction control [82](#)
- Transmission lock, refer to Changing the selector lever positions [56](#)
- Transmission, overriding the selector lever lock with Steptronic transmission [57](#)
- Transmission, refer to Manual transmission [55](#)
- Transmission, see Steptronic transmission [55](#)
- Transporting children safely [43](#)
- Trip-distance counter, refer to Trip odometer [58](#)
- Triple turn signal activation [51](#)
- Trip odometer [58](#)
- Trunk lid, refer to Tailgate [26](#)
- Trunk, refer to Cargo area [26](#)
- Turning lights, refer to Adaptive Light Control [68](#)
- Turn signal, bulb replacement [174](#)
- Turn signal indicator lamp [14](#)
- Turn signals [51](#)
- Turn signals, triple turn signal activation [51](#)
- U**
- Uniform Tire Quality Grading/UTQG [156](#)
- Unintentional alarms, avoiding [31](#)
- Units, average fuel consumption [61](#)
- Units, temperature [61](#)
- Universal remote control [94](#)
- Unlocking from the inside [25](#)
- Unlocking, from the outside [22](#)
- Unlocking, tailgate [28](#)
- Unlocking, without remote control, refer to Comfort Access [28](#)
- Upholstery care [188](#)
- Upholstery material care [188](#)
- USB audio interface [131](#)
- V**
- Vanity mirror [96](#)
- Vehicle battery [179](#)
- Vehicle, breaking in [110](#)
- Vehicle care [187](#)
- Vehicle care, refer to Care [186](#)
- Vehicle equipment [6](#)
- Vehicle paintwork, care [188](#)
- Vehicle storage [190](#)
- Vehicle, switching off [50](#)
- Vehicle wash [186](#)
- Ventilation, air conditioner [93](#)
- W**
- Warning and indicator lamps [15](#)
- Warning and indicator lamps, overview [191](#)
- Warning messages, refer to Check Control [64](#)
- Warning triangle [181](#)
- Washer/wiper system [52](#)
- Washer/wiper system, rain sensor [52](#)
- Washer/wiper system, washer fluid [54](#)
- Washer fluid [54](#)
- Washer fluid reservoir [54](#)

Washing, vehicle 186  
Welcome lights 68  
Wheel change 178  
Wheels and tires 152  
Wheels, changing 159  
Wheels, Flat Tire Monitor  
FTM 74  
Window, convenient operation 23  
Windows 32  
Windows, care 187  
Windows, closing 33  
Windows, defrosting and defogging 89  
Windows, opening 33  
Windows, pinch protection 33  
Windshield defroster 92  
Windshield, defrosting and defogging 89  
Windshield, defrosting, refer to Defrosting windows 89  
Windshield wash 52  
Windshield washer fluid 54  
Windshield wash, rear window 54  
Windshield wash, reservoir for washer fluid 54  
Windshield wash, washer fluid 54  
Windshield wiper blades, changing 171  
Windshield wiper, refer to Washer/wiper system 52  
Winter storage, care 190  
Winter tires 159  
Winter tires, tread 157  
Wiper blades, care 187  
Wiper blades, changing 171  
Wiper fluid 54

## Y

Your individual vehicle, settings, refer to Personal Profile 20





01 40 2 961 084 ue

**DRIVE ME.**